





# Product Manual - SparkPNT FPX



# Table of contents:

## Welcome

-  Getting Started
-  Connectivity
- Equipment Overview
- GIS Apps
- GNSS Basics
-  Placement Guidelines
- Firmware Updates
- Specifications
-  Repairs

## Quickstart Guide

- Parts List
- Device Overview
  - Power
    - Battery
  - Connectivity
    - BLE
    - WiFi
  - Status Indicators
- Initial Setup
  - Orientation and Alignment
  - Placement and Surroundings
    - Obstructions and Multipath
    - Dilution of Precision
    - RF Interference Sources
- Rover
  - Rover with RTK
  - Rover with PPP-RTK
- Base Station
  - Base Station with NTRIP

## Equipment Overview

- Parts List
- Carrying Case
- Product Overview
  - Enclosure

- GNSS Antenna
  - Antenna and North Reference Points
  - Mount Point
- Power
  - Battery and Charging
- OLED Display
- Buttons
- Indicators
  - Status LEDs
  - Buzzer
- Data/Communication Connections
  - SD Card
  - JST Connector
  - Lemo Connector
  - USB Connector
  - SMA Connector
- Specifications

## Surveying Setup

- Assembly
  - Orientation and Alignment
  - Placement and Surroundings
    - Obstructions and Multipath
    - Dilution of Precision
    - RF Interference Sources

## Device Operation

-  Connectivity
- Modes of Operation
- Corrections Services
- Configuration Settings
- Firmware Updates

## Connectivity

- BLE
- WiFi

## Modes of Operation

- Rover
  - Rover with RTK
  - Rover with PPP-RTK

- Base Station
  - Base Station with NTRIP

## Corrections Services

- Priorities

## Configuration Settings

- Profiles
  - Create or Rename Profile
  - Configure a Profile
  - Reset a Profile
- GNSS and Rover Settings
- Base Station
- Point Perfect Service
- Data Ports
- WiFi Connection
  - WiFi Mode
  - WiFi Networks
- TCP/UDP Connection
- Radio Settings
- Correction Priorities
- Instrument Heights
- System Configuration
  - Firmware Update
  - Factory Reset

## Firmware Updates

- Updating ESP32 Firmware
  - Updating Firmware Over-The-Air
  - Updating Firmware From WiFi
- Updating mosaic-X5 Firmware

## Resources & Support

- Technical Support
- Warranty and Returns
- Repair Manual
- Technical Resources

## Technical Support

- Order and Shipping Issues
- Troubleshooting Tips
  - Galileo HAS

- [Battery Life](#)

## Warranty and Returns

- [Terms of Service](#)
- [Returns Process](#)

## Repair Manual

- [Open the Enclosure](#)
- [Remove the Antenna Stackup](#)
  - [Swap Antenna](#)
  - [Reattach Antenna](#)
- [Remove the GNSS Flex Module](#)
  - [Swap Modules](#)
- [Remove the Mainboard PCB](#)
  - [Replace the Mainboard PCB](#)
- [Remove the Battery Plate](#)

## Technical Resources

- [Reference Documents](#)
- [Product Specifications](#)

## Reference Documents

- [Latest Firmware](#)
- [Technical Documentation](#)

## Product Specifications

# Welcome



This is the online product manual for the SparkPNT FPX; a high-performance, precision, MFi certified, all-band GNSS RTK combination rover and base station. If this is your first time using the FPX, follow check out our [Quick Start Guide](#) for initial instructions on setting up the FPX as a base station or begin surveying with your mobile device. Again, thank you for purchasing our SparkPNT FPX!

## Getting Started

A quickstart guide for the FPX

## Connectivity

How-to pair the FPX with your mobile device

## Equipment Overview

A complete overview of the FPX and its interfaces

## **GIS Apps**

A guide for GIS apps on Android and iOS devices

## **GNSS Basics**

A basic guide on GNSS surveying

## **Placement Guidelines**

Tips for precision measurements

## **Firmware Updates**

A guide for updating the firmware on the device

## **Specifications**

The hardware specifications for the FPX

## **Repairs**

A disassembly guide to replace or repair damaged components



# Quickstart Guide

The SparkPNT FPX is a cost-effective, rugged, MFi certified, all-band GNSS RTK surveying unit that can be upgraded and features a built-in RF transceiver. Its combination rover and high-precision base station functions are designed to optimize your on-site workflow.

Unlike other surveying devices, the GNSS receiver inside of SparkPNT FPX can be upgraded when GNSS technology improves, for additional capabilities, or just to match the rest of your fleet. The IP67 rated enclosure is constructed with an anodized aluminum body and a reinforced plastic cover. This entire kit ships in a hard-sided case, including additional accessories, and an appreciation sticker; extra silicon bumpers are also included to facilitate unit identification or serve as replacements.

## Parts List

The SparkPNT FPX comes shipped inside a hard-sided carrying case with a few accessories to users get started. Below, is an overview of all the parts included with your purchase:



*All the parts included in the kit.*



*The individual components laid outside of the carrying case.*

1. Carrying Case
2. SparkPNT FPX
3. Silicone bumper set
4. USB-C Cable
5. USB-C Charger (65W)
6. Thread Adapter (1/4" to 5/8")
7. LoRa Antenna (915MHz, 2dBi)

***i*** NOTE

Any available replacement parts are linked in the list above. Additionally, [international adapter sockets](#) can be purchased separately for the power adapter, if required.

# Device Overview

## ! INFO

Tilt compensation is not supported by this device.

## Power

To power the device on or off, hold the (🔌) power button down for more than 3 seconds. When the device powers on, it will beep once; whereas, the device will beep three times when it powers down.



*Power button on the front of the device.*

## Battery

The FPX features a 49Whr battery and supports PD charging, up to 10W.



*Users can access the USB-C port, under the rubber cover, on the bottom of the device.*

- **Battery Charging** - The FPX supports PD charging up to 10W; this allows a fully discharged FPX to be charged to 100% in a few hours. Users can access the USB-C port, under the rubber cover on the bottom of the device.

 **TIP**

Don't forget to fully close the rubber cover. The enclosure's IP67 ingress rating (*waterproof to 1 meter, for up to 30 minutes*), is only valid when the all the covers are sealed.

- **Battery Capacity** - The FPX includes a 7.2V 6.8Ahr (48.96Whr) battery. This should allow the device to run continuously for more than 50 hours, even in the worst-case conditions.

## Connectivity

In order to get corrections or configure the device, users should pair the device with their phone. Double-tap the power button (*press  twice, within 1 second*) to connect to your device.

## BLE

To provide RTK corrections from an NTRIP caster (or server), view the device's position in real-time, and manage datapoints, it is best to utilize a 3rd party app on a mobile device. Users can then, pair the FPX to their mobile device with a BLE connection.

For a Bluetooth connection, follow these steps:

1. Power the device on.
  - Hold the (🔌) power button for more than 3 seconds. It will beep once, indicating it has turned on.
2. Once the device has powered up; double-tap the power button (*press 🔌 twice, within 1 second*).
  - The device will beep twice indicating it is waiting for incoming connections.
3. On your mobile device, connect to BLE device named `SparkPNT FPX-3AF1`.

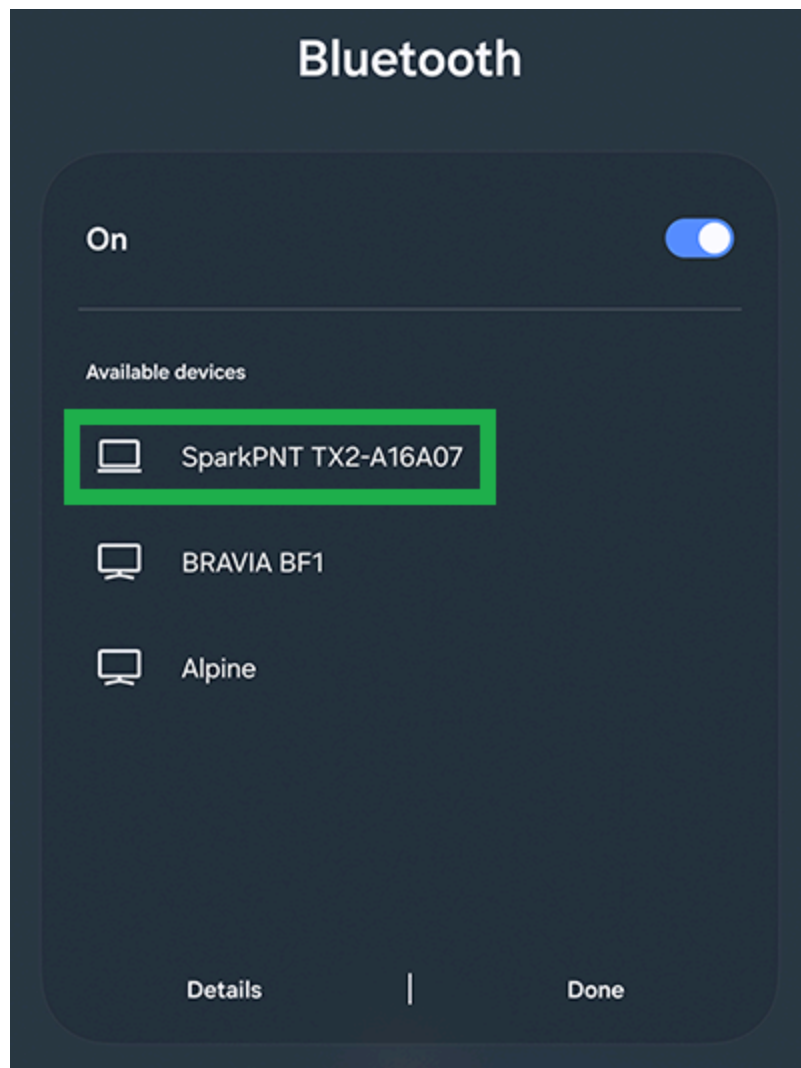

*Pairing from an Android device.*

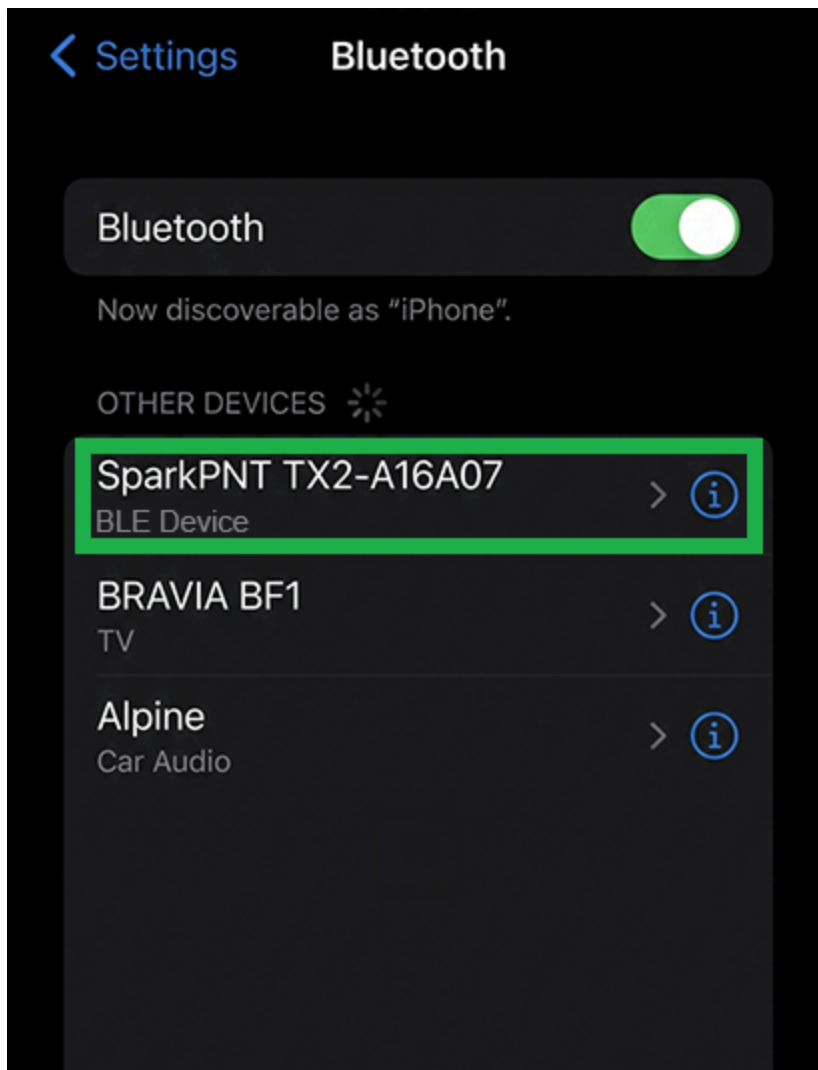

*Pairing from an iOS device.*

4. Once pair, you be able to access the device in your favorite [GIS app](#).

## WiFi

To change the configuration settings of the FPX, it is easiest to connect to the device's WiFi access point and pull-up the configuration webpage. Once connected, users can access the configuration webpage from a browser using the <https://rtk.local> URL address.

To get into browser configuration, follow these steps:

1. Power the device on.
  - Hold the (🔌) power button for more than 3 seconds. It will beep once, indicating it has turned on.

2. Once the device has powered up; double-tap the power button (*press  twice, within 1 second*).
  - o The device will beep twice indicating it is waiting for incoming connections.
3. On your mobile device, connect to WiFi network named `RTK Config`. Upon connecting, your phone may warn you that the WiFi network is not connected to the internet. This is normal; stay connected and open a browser.

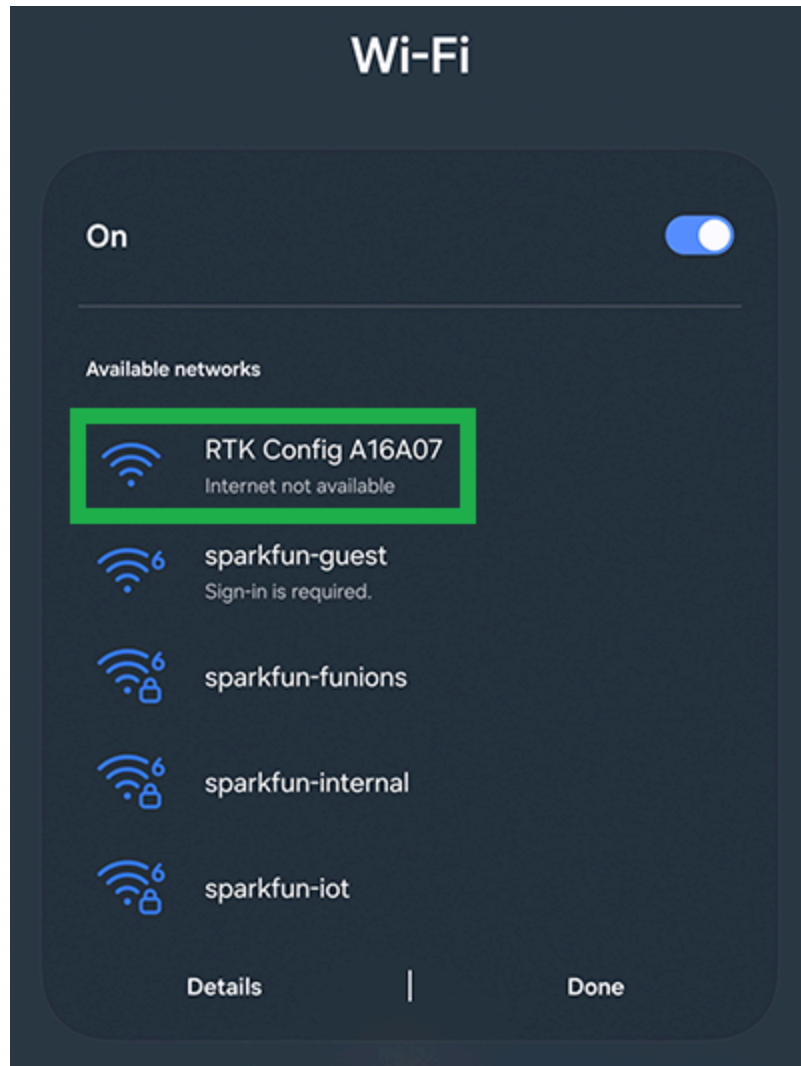

*Connecting from an Android device.*

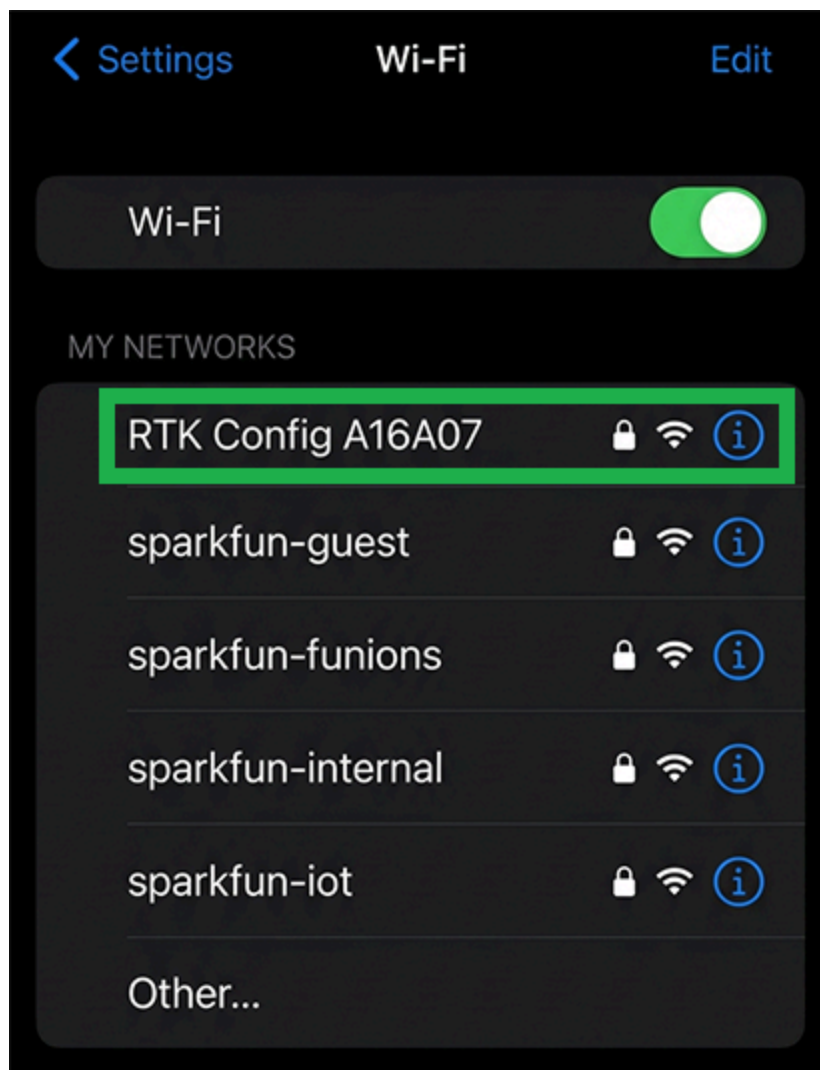

*Connecting from an iOS device.*

**⚠ WARNING**

If you have problems, try disabling mobile/cellular data on your mobile device. The device or browser might be using the cellular connection for its internet access; however, we want to disable this setting to ensure that your mobile device remains on the WiFi access point for the browser.

4. Once the browser is opened, you should be automatically re-directed to the configuration webpage. If not, open a browser (Chrome is preferred) and type `http://rtk.local` into the address bar.

```
https://rtk.local/
```



http://rtk.local/



# SPARK PNT DEVICE SETUP



Model: TX2

RTK Everywhere Firmware: v3.2

LG290P Firmware: LG290P03AANR02A01S ID: 000018A5DA5A8D19

Device Bluetooth ID: E61E07

LLh: 0.00000000, 0.00000000, 0.000 (APC)

ECEF: 6378137.000, 0.000, 0.000

Profile Configuration ▾

GNSS Configuration ▾

Base Configuration ▾

PointPerfect Configuration ▾

Ports Configuration ▾

WiFi Configuration ▾

TCP / UDP Configuration ▾

Radio Configuration ▾

Corrections Configuration ▾

Instrument Configuration ▾

System Configuration ▾

Save Configuration 

Exit and Reset 

Browser with `rtk.Local` webpage.

## Status Indicators

There are two LED status indicators on the front of the FPX.



*The LED status indicators on the FPX.*

- The GNSS icon (📶) indicates the GNSS solution status.
  - A yellow LED will blink once per second when a GNSS fix is achieved.
  - A green LED will illuminate solid when RTK Fix is achieved.
- The Connection icon (↑↓) indicates the WiFi or BLE connection status.
  - The LED blinks once per second while waiting for a connection.
  - The LED will turn solid, once it is connected to a phone, laptop, WiFi network, etc.

## Initial Setup

Users simply need to attach their FPX to a surveying post or mount point using the 5/8"-11 TPI threaded insert on the bottom of the FPX. This kit also includes a [1/4" adapter](#) for additional mounting options.



*The 5/8"-11 TPI threaded insert on the base of the FPX.*

## Orientation and Alignment

For the most accurate positioning, users should align their device as vertically straight as possible. Additionally, the user interface (front of the device) should be facing north as defined by the device's [north reference point](#).

Antenna Type Code:

**SPNFACETFP** **NONE**

Brand code: SPN (SparkPNT)

Antenna model: FACET FP

Antenna code: SPNFACETFP

Radome code: NONE

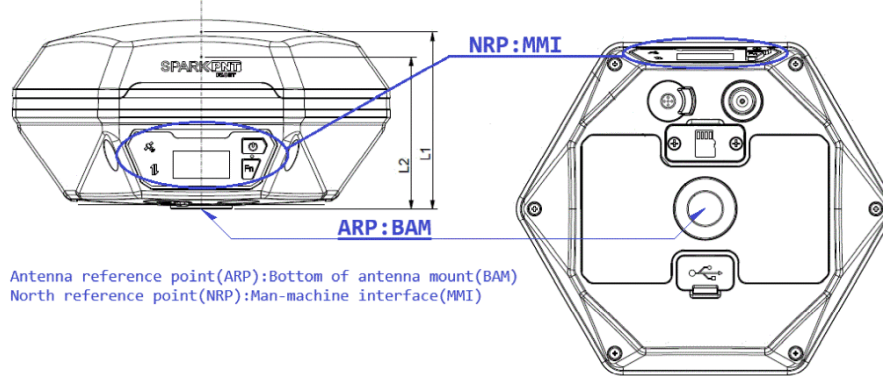

Antenna reference point(ARP):Bottom of antenna mount(BAM)  
North reference point(NRP):Man-machine interface(MMI)

*The antenna reference point and north reference point of the FPX.*

When marking positions, users can also provide the pole height and distance between the ARP and APC in the RTK Everywhere firmware. This will allow users to accurately mark their positions based on the bottom of the surveying pole.

## Placement and Surroundings

This section provides general placement considerations for precision GNSS surveying. Below, are some useful examples of ideal locations for surveying.

- Ideal locations
  - Open fields
  - Hilltops
- Poor locations
  - Canyons and valleys
  - Cities or dense urban areas
  - Dense foilage

## Obstructions and Multipath

For precision GNSS surveying, the receiver works best with a wide-open, unobstructed view of the sky.

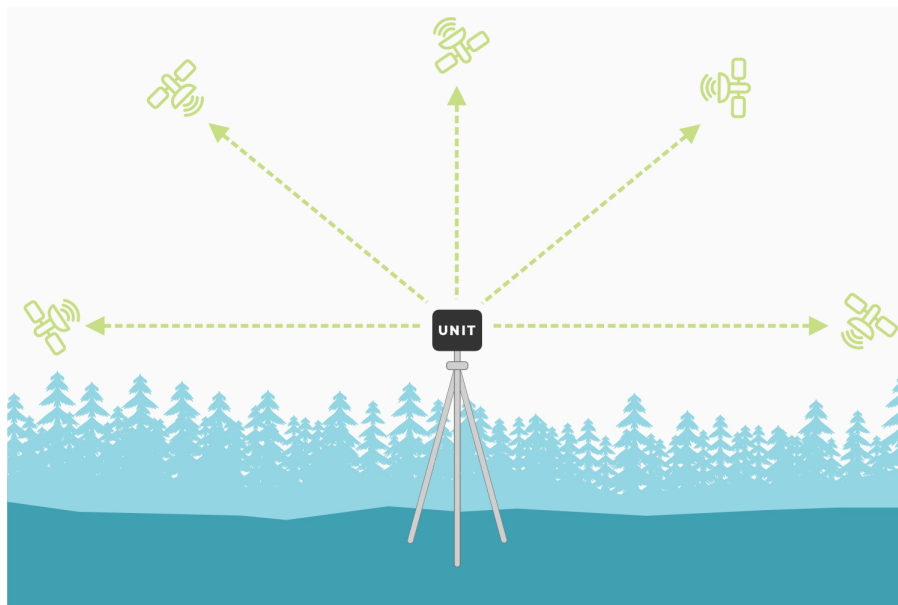

*A wide-open, unobstructed view of the sky offers increased accuracy and precision.*

Obstructions can create multiple paths for signals. This introduces timing errors into the solutions provided by the GNSS receiver reducing its precision and accuracy.

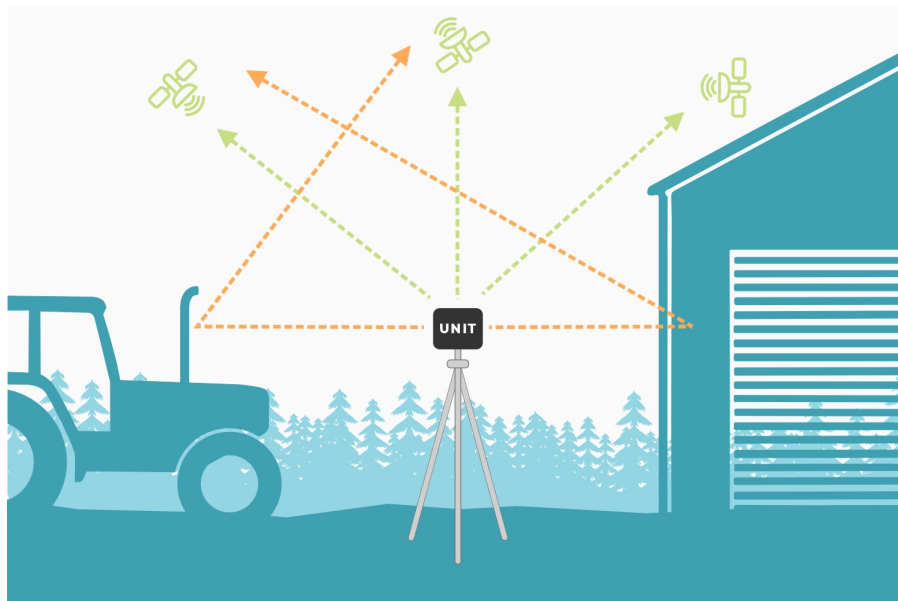

*The increased signal paths, introduce timing errors into the solutions provided by the GNSS receiver.*

**! INFO**

By default, the FPX ignores any signals from satellites positioned below, 15° above its horizon (see image). This mitigates any multi-path errors from any obstacles on the horizon; such as

buildings, trees, cars, etc.

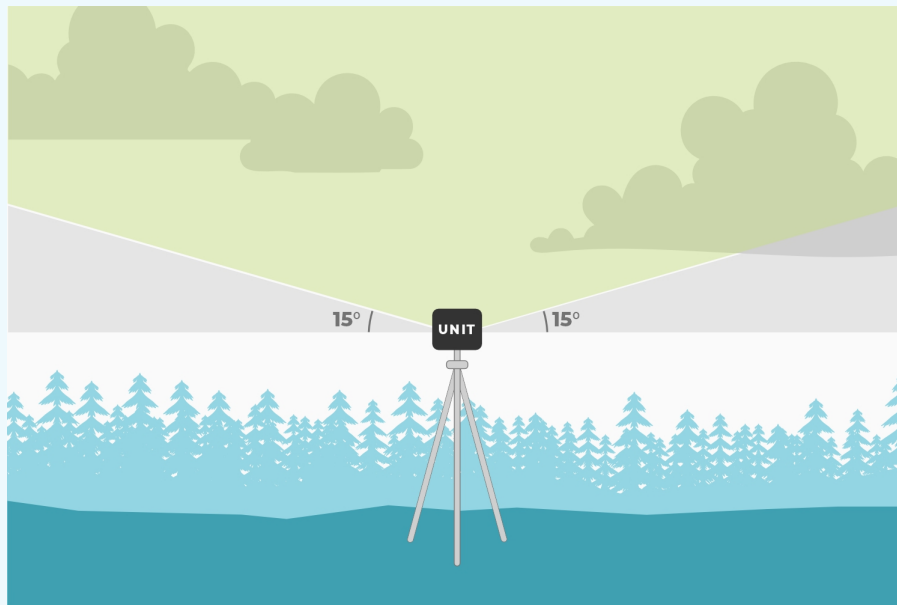

*The FPX ignores any signals from the horizon (<math>< 15^\circ</math>) and only accepts signals from above (green).*

Obstructions can also reduce the performance of the GNSS receiver and the precision of its solutions.

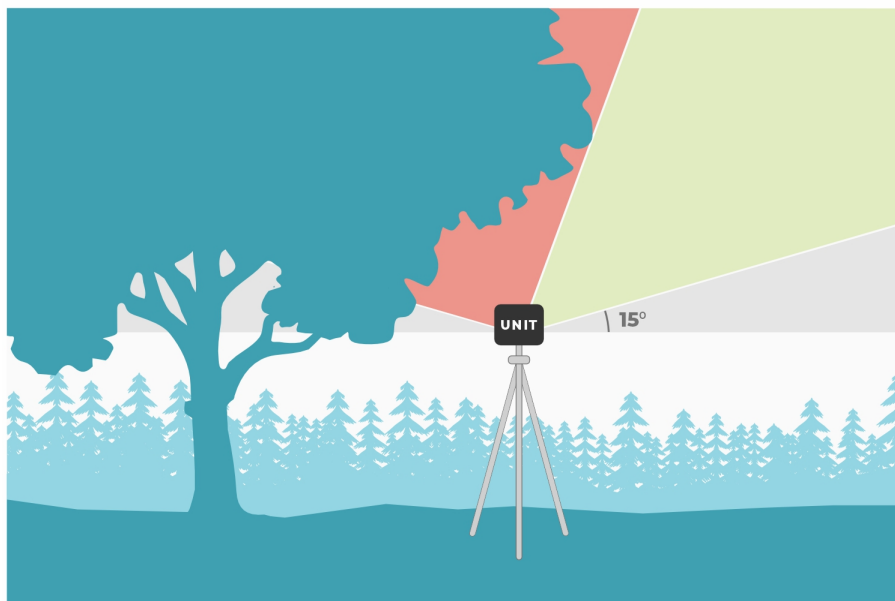

*Obstructions reduce the distribution and number of satellites used in solutions.*

**Dilution of Precision**

The geometric arrangement of satellites, significantly influences the precision of GNSS solutions. A well-distributed arrangement of satellites allows for more accurate positioning by minimizing errors related to signal distortion and multipath effects. When satellites are positioned at wide angles relative to each other, the geometric *dilution of precision* improves, enhancing precision of the positioning solutions. Conversely, when satellites cluster closely together in the sky, it can lead to degradation in the geometric *dilution of precision* and less reliable positioning solutions. Therefore, optimal satellite geometry is crucial for achieving high-precision GNSS solutions.

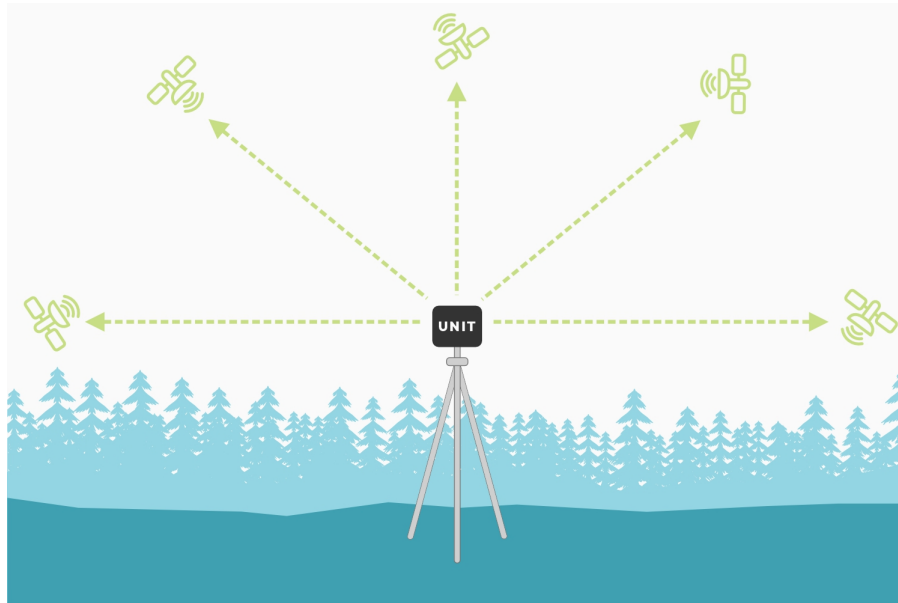

*A wide-open, unobstructed view of the sky offers increased accuracy and precision.*

## **RF Interference Sources**

Nearby electronics can interfere with the reception of the GNSS signals. It is recommended that users limit the use of wireless electronics that produce RF noise. Especially those that operate near the frequencies of GNSS signal bands.

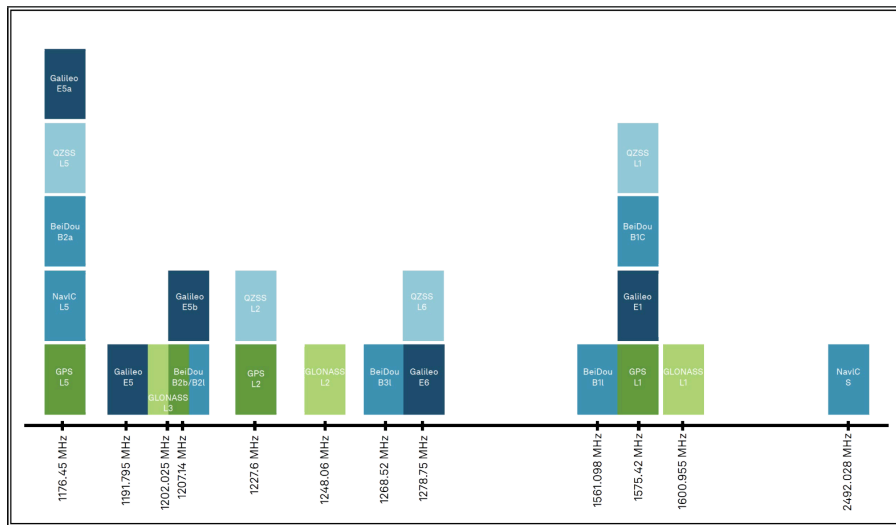

GNSS frequency bands (Source: Novatel)

## Rover

In **Rover** mode, the FPX will receive L1, L2, and L5 GNSS signals from the four constellations (GPS, GLONASS, Galileo, and BeiDou) and output the devices' position with accuracies around 700mm. The device will calculate the position based on the combination of GNSS and any correction signals (primarily SBAS, if available). Similar to a standard-grade GNSS receiver, the FPX will output industry standard NMEA sentences at 2Hz and can broadcast them to any paired Bluetooth® device. The end user will need to parse the NMEA sentences using [commonly available mobile apps](#), [GIS products](#), or embedded devices (there are many open source libraries).

## Rover with RTK

In **Rover with RTK** mode, the FPX will receive GNSS signals and combine them with RTCM correction data to achieve accuracy of approximately 8mm horizontal positional accuracy and 15mm vertical accuracy. The RTCM correction data is most easily obtained over a cellular connection to the Internet using a free app on your phone (see [SW Maps](#) or [Lefebure NTRIP](#)) and sent over Bluetooth®. Additionally, corrections can be obtained over WiFi, or [ESP-NOW](#). Correction data can come from 2nd unit setup as a base station, from a free local base station, or from a paid service. See the [Quick Start guide](#) and the [NTRIP Client](#) for more information.

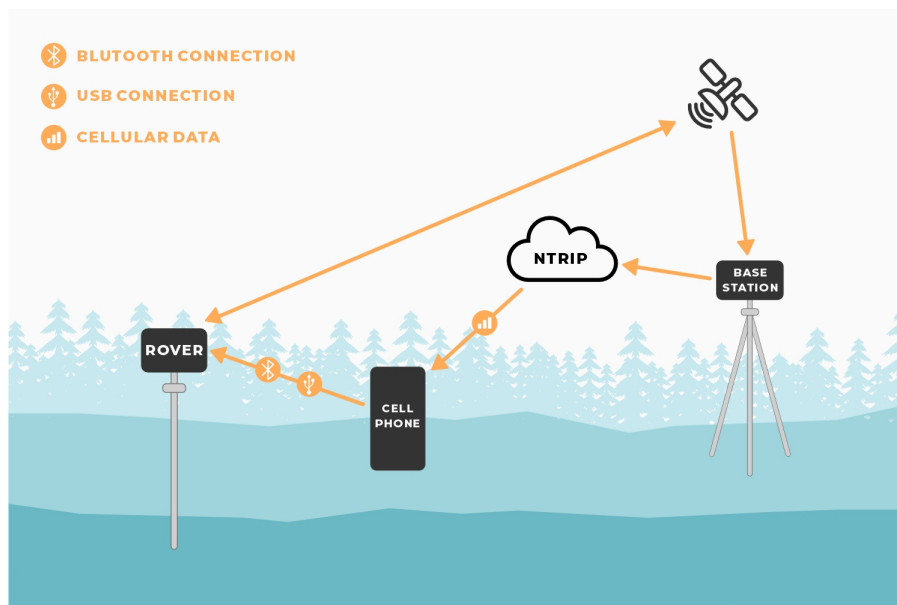

*The device connectivity for RTK corrections from an NTRIP network.*

## Rover with PPP-RTK

In **Rover with PPP-RTK**, the FPX will receive GNSS signals and combine them with correction data provided over an IP connection (usually a cell phone hotspot). The corrections are State Space Representation (SSR) based and are also known as PPP-RTK. These corrections are obtained from [ublox's PointPerfect network](#). Time to RTK Fix can take up to 300 seconds and has 14 to 60mm horizontal positional accuracy.

## Base Station

In **Base Station** mode the device is mounted to a fixed position (like a tripod or roof) and will initiate a survey. After 60 to 120 seconds the survey will complete and the FPX will begin transmitting RTCM correction data over the built in 2.4GHz radio (if [ESP-NOW](#) is enabled). A base is often used in conjunction with a second FPX unit (or [RTK Facet](#), [RTK Surveyor](#), [Express](#), [Express Plus](#), etc) set to `Rover` to obtain the 8mm accuracy. Said differently, the Base sits still and sends correction data to the Rover so that the Rover can output a really accurate position. The relative accuracy of this mode is 8mm base-to-rover but has higher (up to a meter) of absolute inaccuracy. See [how to set up a permanent base](#) to decrease the absolute inaccuracy.

## Base Station with NTRIP

In **Base Station with NTRIP** the device will enter Base Station mode. If WiFi is available, and the [NTRIP Server\(s\)](#) is enabled, its corrections will be broadcast to up to four NTRIP casters and made available to any rover that also has internet access and is within 10-20km.

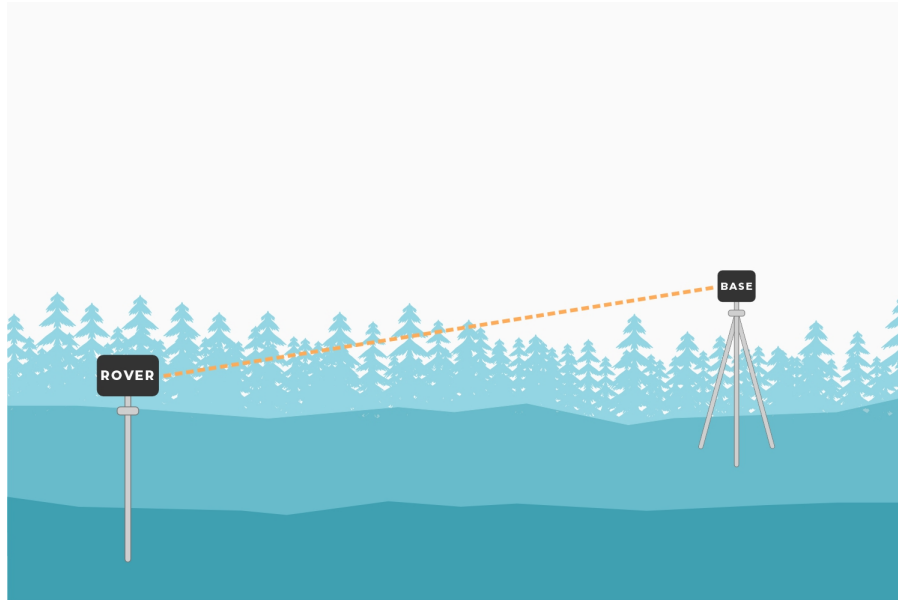

*The device connectivity for RTK corrections from an base station.*

# Equipment Overview

The SparkPNT FPX is a cost-effective, rugged, MFi certified, all-band GNSS RTK surveying unit. Unlike other high-precision RTK surveying devices, the GNSS receiver inside of SparkPNT FPX can be easily upgraded to meet your performance requirements, match the capabilities of your fleet, or when GNSS technology improves. The FPX provides Bluetooth and WiFi connectivity to any mobile device, including Apple iOS devices with its MFi certification. We have also included a built-in 1W 915MHz LoRa radio, to transmit/receive RTK corrections directly with other units that are over 16km (> 10mi) away.



**Meet the Facet FP: The First User-Upgradable GI**  
SparkFun Electronics



Watch on

We have designed the FPX to optimize your on-site workflow:

- When it comes to fleet management, configuring another device is as simple as swapping out the SD card; gone are the days of needing to copy/paste credentials and settings.
- To start surveying positions, simply pair with the FPX on any smartphone or tablet, open your preferred GIS app, and access their NTRIP corrections service using the internet/cellular connection of your mobile device.
- The SparkPNT FPX can also operate as a base station, to broadcast RTK corrections and function as an NTRIP caster/server.
  - When working on a tight deadline, users can also implement our **Base Assist** function to automatically configure the base station's position in minutes. Great for scenarios, where only precise measurements are required and not the accuracy of their global position; such as surveying the layout of a building.

- Using its WiFi capabilities, users can configure the FPX to operate as an NTRIP caster/server on a local WiFi network, be used as an access point, or even connect to another SparkPNT device directly using the WiFi 2.4GHz transceiver, great for regions where the 915MHz radio can't be utilized.

This is all housed in an IP67 rated enclosure and constructed with an anodized aluminum body and a reinforced plastic cover. Our entire kit ships in a hard-sided case, including additional accessories, and a appreciation sticker. We have even included extra silicon bumpers to facilitate unit identification or serve as replacements.

## Parts List

The SparkPNT FPX comes shipped inside a hard-sided carrying case with a few accessories to users get started. Below, is an overview of all the parts included with your purchase:



*All the parts included in the kit.*



*The individual components laid outside of the carrying case.*

1. Carrying Case
2. SparkPNT FPX
3. Silicone bumper set
4. USB-C Cable
5. USB-C Charger (65W)
6. Thread Adapter (1/4" to 5/8")
7. LoRa Antenna (915MHz, 2dBi)

**(i) NOTE**

Any available replacement parts are linked in the list above. Additionally, [international adapter sockets](#) can be purchased separately for the power adapter, if required.

## Carrying Case

The FPX comes with a hard-sided case that includes two holes for pad locks (with shackles up to **6mm** in diameter).



*The hard-sided carrying case.*

 **TIP**

We recommend limiting the shackle diameter to less than **6mm**; a 1/4" (6.35mm) shackle will not fit without modifying the case.

## Product Overview

The FPX features a rugged aluminum and plastic enclosure, calibrated ceramic GNSS antenna, high-capacity battery, 5/8" threaded base, a basic user interface, and weather-protected data interfaces. The user interface has an OLED display, two user buttons, and two status LEDs. Users can find the data interfaces located on the bottom of the device; including the SD card slot, JST-GH connector, USB-C connector, 5-pin data port connector, and SMA connector. The enclosure is IP67 waterproof, but only if the data interfaces on the bottom are covered.

## Enclosure

The FPX features a rugged enclosure made of a cast aluminum body with a plastic cover around its embedded ceramic antenna. The enclosure is IP67 rated and is waterproof to 1 meter, for up to 30 minutes, when the data interfaces on the bottom are covered.



*The enclosure of the FPX.*

### **⚠ WARNING**

The device should not be considered as IP67 waterproof, if the LoRa antenna is attached or any of the ports on the bottom are exposed. The rubber covers need to be fully seated, cover for the JST/SD card slot attached, and the SMA connector capped for the enclosure to qualify for the IP67 ingress protection rating.



*The data interfaces on the bottom of the FPX, covered for the IP67 rating.*

## GNSS Antenna

Underneath its plastic cap, the FPX features a specially tuned multi-frequency (L1/L2/L5) GNSS antenna and 2.4GHz BLE/WiFi extension antenna.

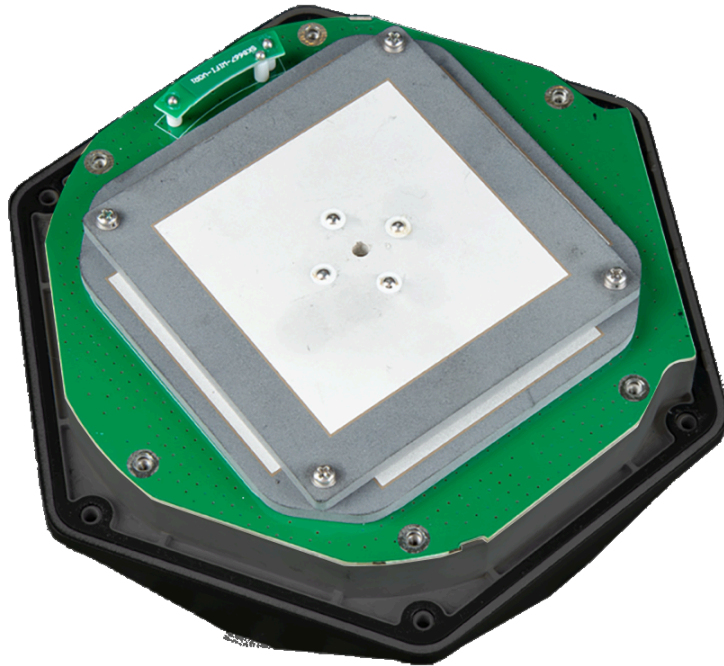

*The primary L2, L2, L5 ceramic antenna inside the FPX.*

 **TIP**

Don't forget that GNSS signals are fairly weak and can't penetrate buildings or dense vegetation. The GNSS antenna should have an unobstructed view of the sky.

### **Antenna and North Reference Points**

The mounting point at the bottom of the device, where the threaded insert is located serves as the device's ARP (antenna reference point). Additionally, the user interface (front of the device) serves as the device's NRP (north reference point). The distance between the ARP on the FPX to the L1 APC (antenna phase center) is **131.7mm** and **126.2mm** to the L2/L5 APC; with an average of **128.95mm**.

Antenna Type Code:  
**SPNFACETFP** **NONE**

Brand code: SPN (SparkPNT)      Antenna model: FACET FP  
Antenna code: SPNFACETFP      Radome code: NONE

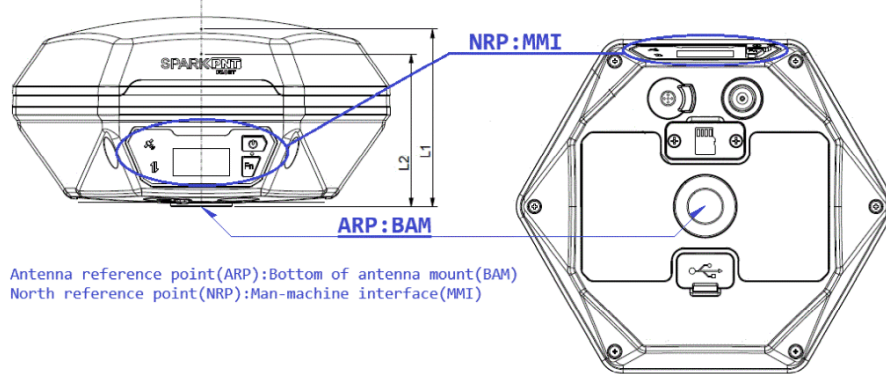

Antenna reference point(ARP):Bottom of antenna mount(BAM)  
North reference point(NRP):Man-machine interface(MMI)

*The antenna reference point and north reference point on the FPX.*

## Mount Point

The bottom of the FPX features a standard 5/8"-11 TPI threaded insert. This is commonly found on surveying equipment and is compatible with most surveying poles. The FPX kit also includes a 1/4" to 5/8" thread adapter for additional mounting options.



*The 5/8"-11 TPI threaded insert on the base of the FPX.*

### **!** INFO

The center of the threaded insert, on the plane of the device's base, serves as the ARP (antenna reference point) for the device.

## **Power**

To power the device on or off, hold the (⏻) power button down for more than 3 seconds. When the device powers on, it will beep once; whereas, the device will beep three times when it powers down.



*Power button on the front of the device.*

## **Battery and Charging**

The FPX features a 49Whr battery and supports PD charging, up to 10W.



*Users can access the USB-C port, under the rubber cover, on the bottom of the device.*

- **Battery Charging** - The FPX supports PD charging up to 10W; this allows a fully discharged FPX to be charged to 100% in a few hours. Users can access the USB-C port, under the rubber cover on the bottom of the device.

 **TIP**

Don't forget to fully close the rubber cover. The enclosure's IP67 ingress rating (*waterproof to 1 meter, for up to 30 minutes*), is only valid when the all the covers are sealed.

- **Battery Capacity** - The FPX includes a 7.2V 6.8Ahr (48.96Whr) battery. This should allow the device to run continuously for more than 50 hours, even in the worst-case conditions.

## OLED Display

The user interface features an OLED display, two status LED indicators, and two user buttons. The OLED display is used to navigate the configuration menu and display a main screen with the status of the FPX.





*The OLED display on the FPX.*

### ! INFO

The center of the user interface also serves as the NRP (north reference point) for the device.

## Buttons

There are two user buttons that can be used to turn the FPX on /off or navigate the menus displayed on the OLED screen.

- Power the device on or off:
  - Hold the (  ) power button down for more than 3 seconds. When the device powers on, it will beep once; whereas, the device will beep three times when it powers down.
- Navigate menu:
  - Open menu: From the main screen, press the (  ) function button once to open the navigation menu.

- Move down/select next option: Press the (Fn) function button navigate down to the next option on the menu of the OLED display.
- Select option/navigate into the sub-menu: Press the (⏻) power button to select an option or navigate into its sub-menu.



*The buttons on the front of the device.*

## Indicators

The FPX also features two LED status indicators and an internal buzzer for audio feedback to the user.

### Status LEDs

There are two LED status indicators on the front of the FPX.



*The LED status indicators on the FPX.*

- The GNSS icon (📶) indicates the GNSS solution status.
  - A yellow LED will blink once per second when a GNSS fix is achieved.
  - A green LED will illuminate solid when RTK Fix is achieved.
- The Connection icon (↑↓) indicates the WiFi or BLE connection status.
  - The LED blinks once per second while waiting for a connection.
  - The LED will turn solid, once it is connected to a phone, laptop, WiFi network, etc.

## **Buzzer**

The FPX also includes an internal buzzer that provides audio feedback for the user. The following prompts are provided:

- Power On: Beep once
- Power Off: Beep three times
- Awaiting a Connection: Beep twice

## **Data/Communication Connections**

There are five data and communication connections on the bottom of the FPX; SD card slot and JST, Lemo, USB-C, and SMA connectors. The SD card slot and JST connector are both enclosed under the same cover.



*The data and communication interfaces on the bottom of the FPX.*

#### **⚠ WARNING**

The device should not be considered as IP67 waterproof, if the LoRa antenna is attached or any of the ports on the bottom are exposed. The rubber covers need to be fully seated, cover for the JST/SD card slot attached, and the SMA connector capped for the enclosure to qualify for the IP67 ingress protection rating.

#### **SD Card**

The SD card slot and [JST-SH connector](#) are covered under the same access port. To access these interfaces, unscrew and remove the cover piece. Users can insert a  $\mu$ SD card that is formatted with

FAT32, with a capacity up to 32GB. The SD card can be used to transfer user profiles between devices, log data points, store diagnostic reports.



*The SD card slot on the bottom of the FPX.*

## **JST Connector**

The SD card slot and JST-SH connector are covered under the same access port. To access these interfaces, unscrew and remove the cover piece. The



*The JST-GH connector on the bottom of the FPX.*

## Lemo Connector

The 5-pin Lemo-style connector is provided to connect the SparkPNT FPX with industrial equipment. It breaks out the `UART` interface of the SparkPNT FPX and is compatible with our [interface cable](#) and `B - Indoor keyed` Lemo connectors.



*The Lemo-style connector on the bottom of the  
FPX.*

 **TIP**

The pin connections from the SparkPNT FPX to the wires in the interface cable, are listed below:

- Red: VIN (6-20V)
- Yellow: RX
- White: TX
- Black: GND

## USB Connector

Users can access the USB-C port, under the rubber cover on the bottom of the FPX.



*Users can access the USB-C port, under the rubber cover, on the bottom of the FPX.*

#### TIP





Don't forget to fully close the rubber cover. The enclosure's IP67 ingress rating (*waterproof to 1 meter, for up to 30 minutes*), is only valid when the all the covers are sealed.

- In most cases, the USB-C post will be accessed to charge the battery. The FPX supports PD charging up to 10W; this allows a fully discharged FPX to be charged to 100% in a few hours.
- For more advanced users, this port can be utilized to configure the FPX, update the device and GNSS receiver firmware, and/or retrieve a diagnosis report for troubleshooting.

When connecting to the USB interface of the SparkPNT FPX to a computer, users will need to install a USB driver to access the data or configure any settings.

#### USB DRIVER

The USB drivers for the CH342 USB-to-Serial converter can be downloaded from the [manufacturer's website](#).

-  **Windows:**  [Download Page for CH343SER.EXE](#)
-  **MacOS:**  [Download Page for CH341SER\\_MAC.ZIP](#)
-  **Linux:** A USB driver is not required for most Linux based operating systems

## SMA Connector

The built-in LoRa radio is primarily utilized to transmit and receive RTK corrections. For the 1W LoRa transceiver to function, users need to connect the 2dBi 915MHz whip antenna to the SMA connector on the bottom of the FPX. When not in use, the rubber cover should be replaced on the connector to maintain the IP67 ingress rating of the enclosure.



*The SMA connector on the bottom of the FPX.*



Don't forget to replace the rubber cover. The enclosure's IP67 ingress rating (*waterproof to 1 meter, for up to 30 minutes*), is only valid when the all the covers are sealed.

## Specifications

Below are the full specifications for this device:

- mosaic-X5 GNSS Receiver
  - Supported Frequency Bands
    - GPS: L1C/A, L1C, L2C, L5
    - GLONASS: L1, L2
    - Galileo: E1, E5a, E5b, E6
    - Beidou: B1I, B2I, B3I, B1C, B2a, B2b
    - QZSS: L1C/A, L1C, L2C, L5, L6
    - NavIC: L5
    - SBAS: L1
  - Accuracy:
    - Autonomous:
      - Horizontal: 0.7m
      - Vertical: 2.5m
    - RTK:
      - Horizontal: 8mm + 1ppm
      - Vertical: 15mm + 1ppm
  - Time to Fix: <28s
- Antenna
  - L1, L2, L5, L6
    - Gain:  $\geq 2.3\text{dBi}$
    - APC (NGS Calibrated):
      - L1: 65.7mm
      - L2/L5: 50.9mm
      - Average: 58.3mm
  - WiFi, BLE
    - 2.4GHz
- Enclosure

- Ingress Protection: IP67 (1m of water for 30 minutes)
- Materials: Aluminum body w/ plastic cap
- Single push button control
- Three LED indicators
- USB-C port w/ rubber cover
- Battery
  - Specs: 7.2V 6800mAh (48.96Whr)
  - Charging: up to 10W
  - Run Time: 32hrs
- Dimensions: 71 x 71 x 147mm (2.8 x 2.8 x 5.8in)
- Weight: 423g (0.93 lbs)

# Surveying Setup

Setting up your hardware is simple.

## Assembly

The FPX has a standard 5/8" 11-TPI threaded base and is compatible with most surveying equipment. Users may elect to mount their mobile device (i.e. phone, laptop, or tablet) to the surveying equipment for ease of operation.



*The SparkPNT FPX attached to a surveying pole.*

## Orientation and Alignment

For the most accurate positioning, users should align their device as vertically straight as possible. Additionally, the user interface (front of the device) should be facing north as defined by the device's [north reference point](#).

Antenna Type Code:

**SPNFACETFP** **NONE**

Brand code: SPN (SparkPNT)

Antenna model: FACET FP

Antenna code: SPNFACETFP

Radome code: NONE

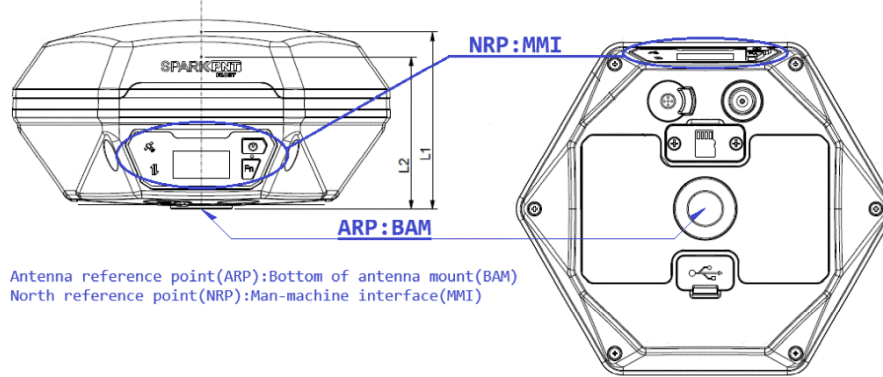

Antenna reference point(ARP):Bottom of antenna mount(BAM)  
North reference point(NRP):Man-machine interface(MMI)

*The antenna reference point and north reference point of the FPX.*

When marking positions, users can also provide the pole height and distance between the ARP and APC in the RTK Everywhere firmware. This will allow users to accurately mark their positions based on the bottom of the surveying pole.

## Placement and Surroundings

This section provides general placement considerations for precision GNSS surveying. Below, are some useful examples of ideal locations for surveying.

- Ideal locations
  - Open fields
  - Hilltops
- Poor locations
  - Canyons and valleys
  - Cities or dense urban areas
  - Dense foilage

## Obstructions and Multipath

For precision GNSS surveying, the receiver works best with a wide-open, unobstructed view of the sky.

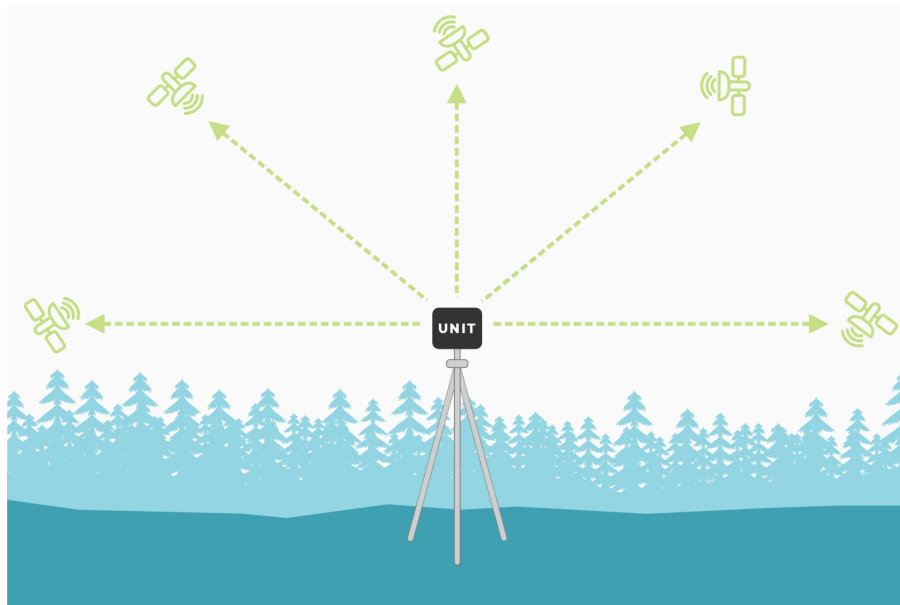

*A wide-open, unobstructed view of the sky offers increased accuracy and precision.*

Obstructions can create multiple paths for signals. This introduces timing errors into the solutions provided by the GNSS receiver reducing its precision and accuracy.

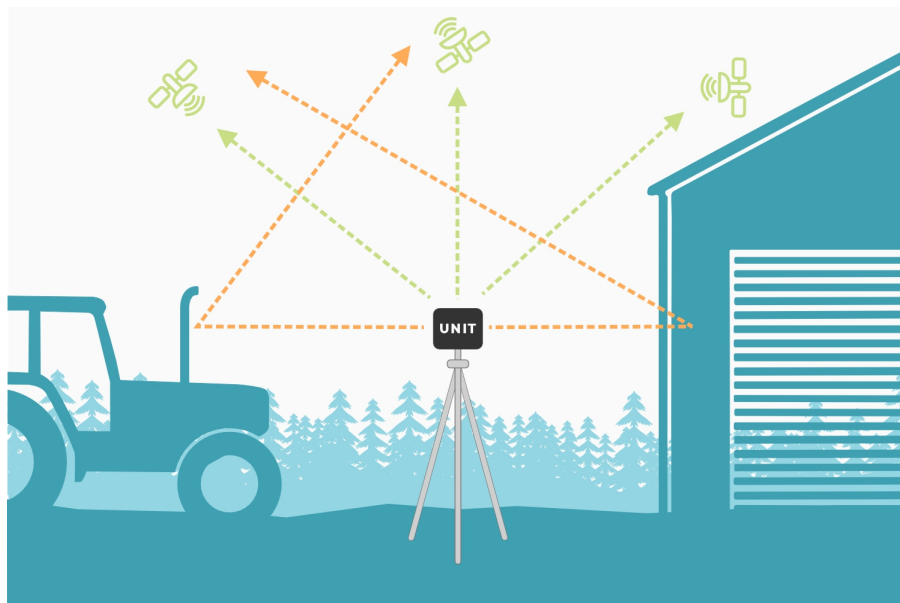

*The increased signal paths, introduce timing errors into the solutions provided by the GNSS receiver.*

**!** INFO

By default, the FPX ignores any signals from satellites positioned below, 15° above its horizon (see image). This mitigates any multi-path errors from any obstacles on the horizon; such as

buildings, trees, cars, etc.

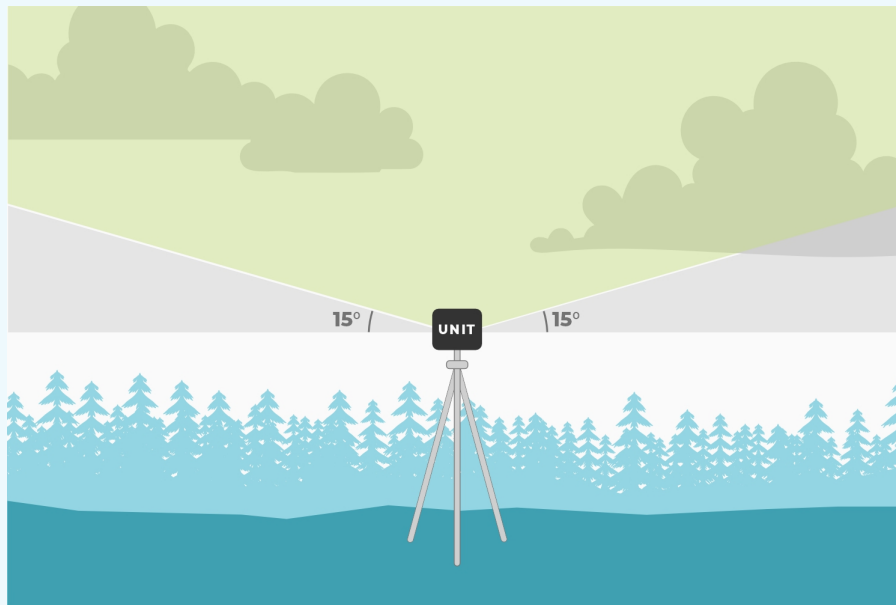

*The FPX ignores any signals from the horizon (<math>< 15^\circ</math>) and only accepts signals from above (green).*

Obstructions can also reduce the performance of the GNSS receiver and the precision of its solutions.

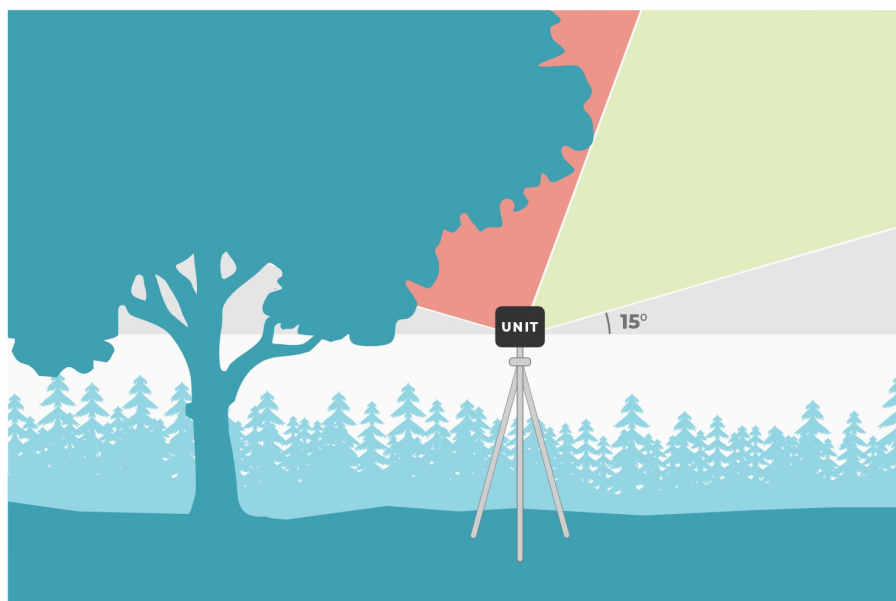

*Obstructions reduce the distribution and number of satellites used in solutions.*

**Dilution of Precision**

The geometric arrangement of satellites, significantly influences the precision of GNSS solutions. A well-distributed arrangement of satellites allows for more accurate positioning by minimizing errors related to signal distortion and multipath effects. When satellites are positioned at wide angles relative to each other, the geometric *dilution of precision* improves, enhancing precision of the positioning solutions. Conversely, when satellites cluster closely together in the sky, it can lead to degradation in the geometric *dilution of precision* and less reliable positioning solutions. Therefore, optimal satellite geometry is crucial for achieving high-precision GNSS solutions.

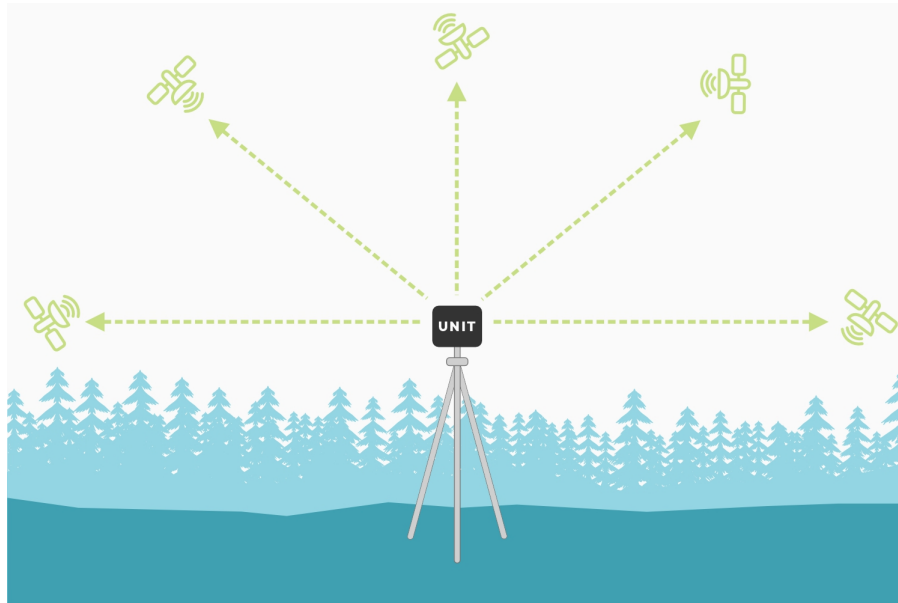

*A wide-open, unobstructed view of the sky offers increased accuracy and precision.*

## **RF Interference Sources**

Nearby electronics can interfere with the reception of the GNSS signals. It is recommended that users limit the use of wireless electronics that produce RF noise. Especially those that operate near the frequencies of GNSS signal bands.

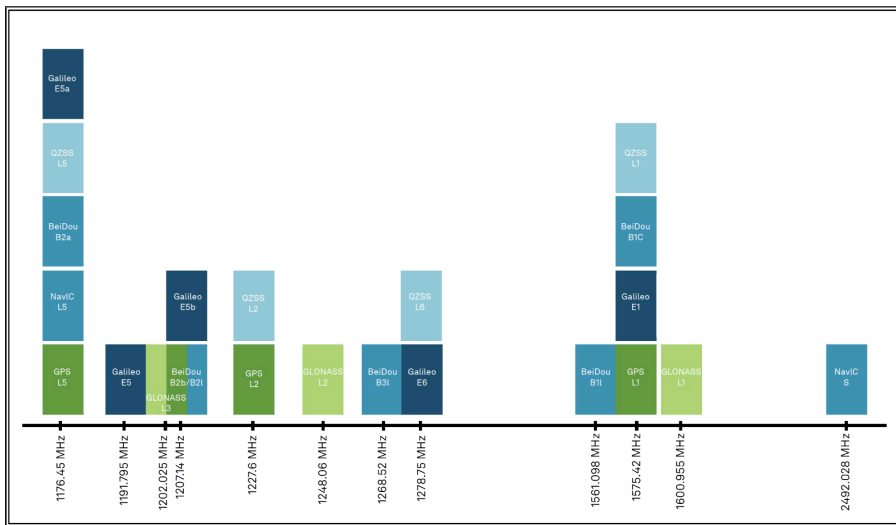

GNSS frequency bands (Source: Novatel)

# Device Operation

## **Connectivity**

How-to connect with your mobile device

## **Modes of Operation**

The primary device functions

## **Corrections Services**

A summary of compatible correction services

## **Configuration Settings**

A guide on the device settings and configuration

## **Firmware Updates**

Update your device with the latest firmware



# Connectivity

In order to get corrections or configure the device, users should pair the device with their phone. Double-tap the power button (*press  twice, within 1 second*) to connect to your device.

## BLE

To provide RTK corrections from an NTRIP caster (or server), view the device's position in real-time, and manage datapoints, it is best to utilize a 3rd party app on a mobile device. Users can then, pair the FPX to their mobile device with a BLE connection.

For a Bluetooth connection, follow these steps:

1. Power the device on.
  - Hold the () power button for more than 3 seconds. It will beep once, indicating it has turned on.
2. Once the device has powered up; double-tap the power button (*press  twice, within 1 second*).
  - The device will beep twice indicating it is waiting for incoming connections.
3. On your mobile device, connect to BLE device named `SparkPNT FPX-3AF1`.

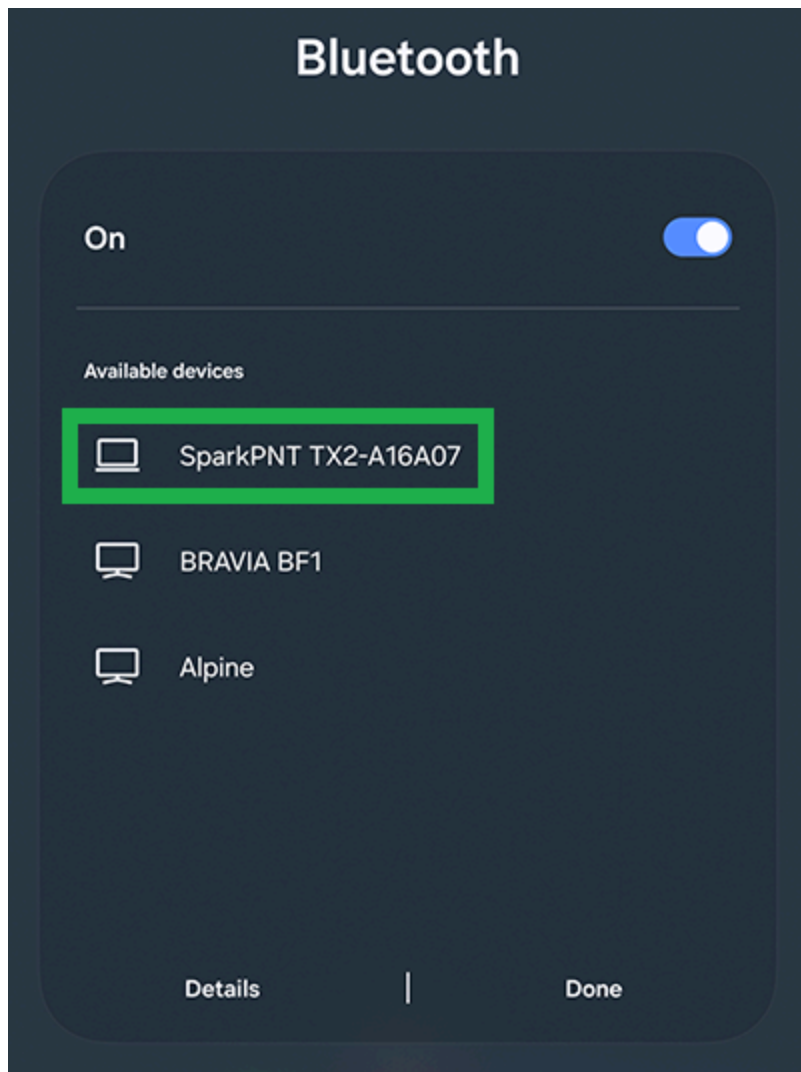

*Pairing from an Android device.*

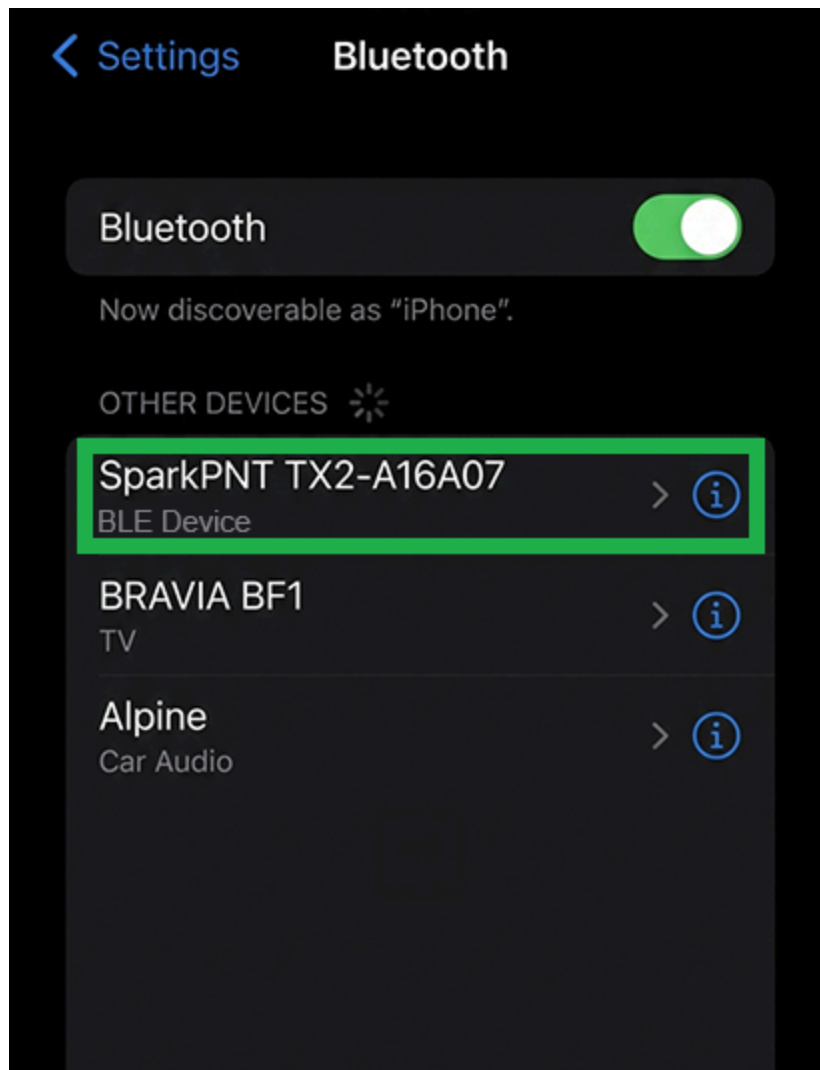

*Pairing from an iOS device.*

4. Once pair, you be able to access the device in your favorite [GIS app](#).

## WiFi

To change the configuration settings of the FPX, it is easiest to connect to the device's WiFi access point and pull-up the configuration webpage. Once connected, users can access the configuration webpage from a browser using the `https://rtk.local` URL address.

To get into browser configuration, follow these steps:

1. Power the device on.
  - Hold the (🔌) power button for more than 3 seconds. It will beep once, indicating it has turned on.

2. Once the device has powered up; double-tap the power button (*press  twice, within 1 second*).
  - The device will beep twice indicating it is waiting for incoming connections.
3. On your mobile device, connect to WiFi network named `RTK Config`. Upon connecting, your phone may warn you that the WiFi network is not connected to the internet. This is normal; stay connected and open a browser.

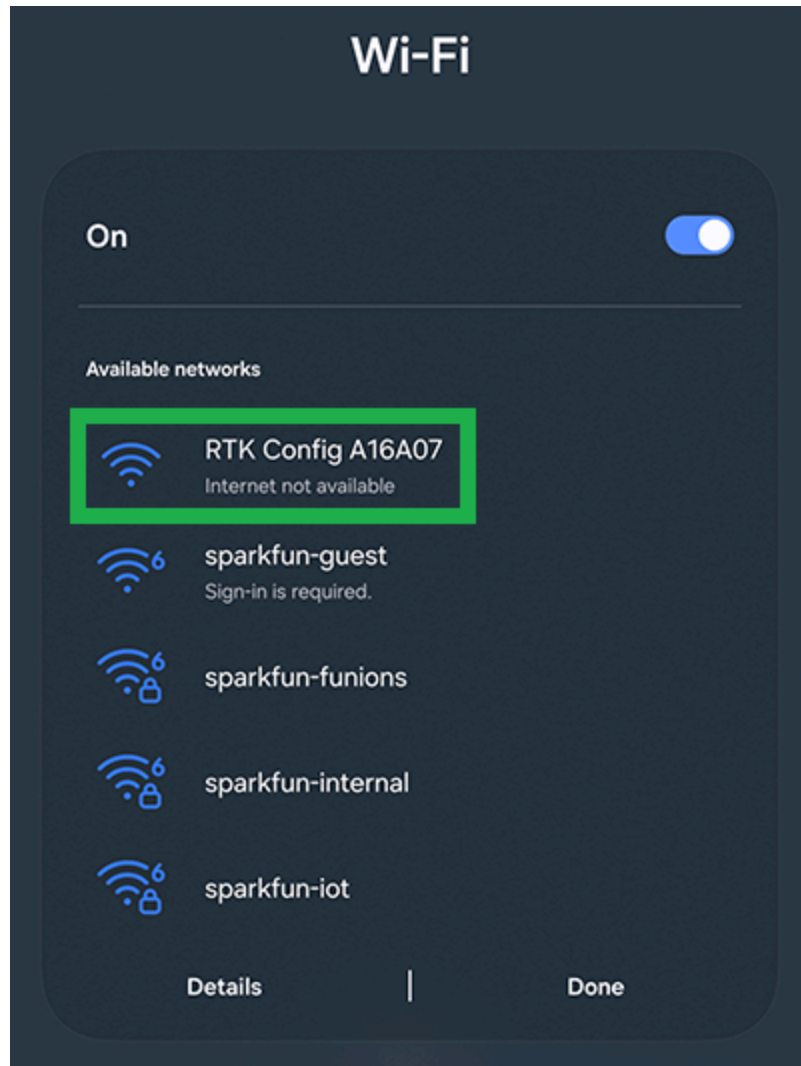

*Connecting from an Android device.*

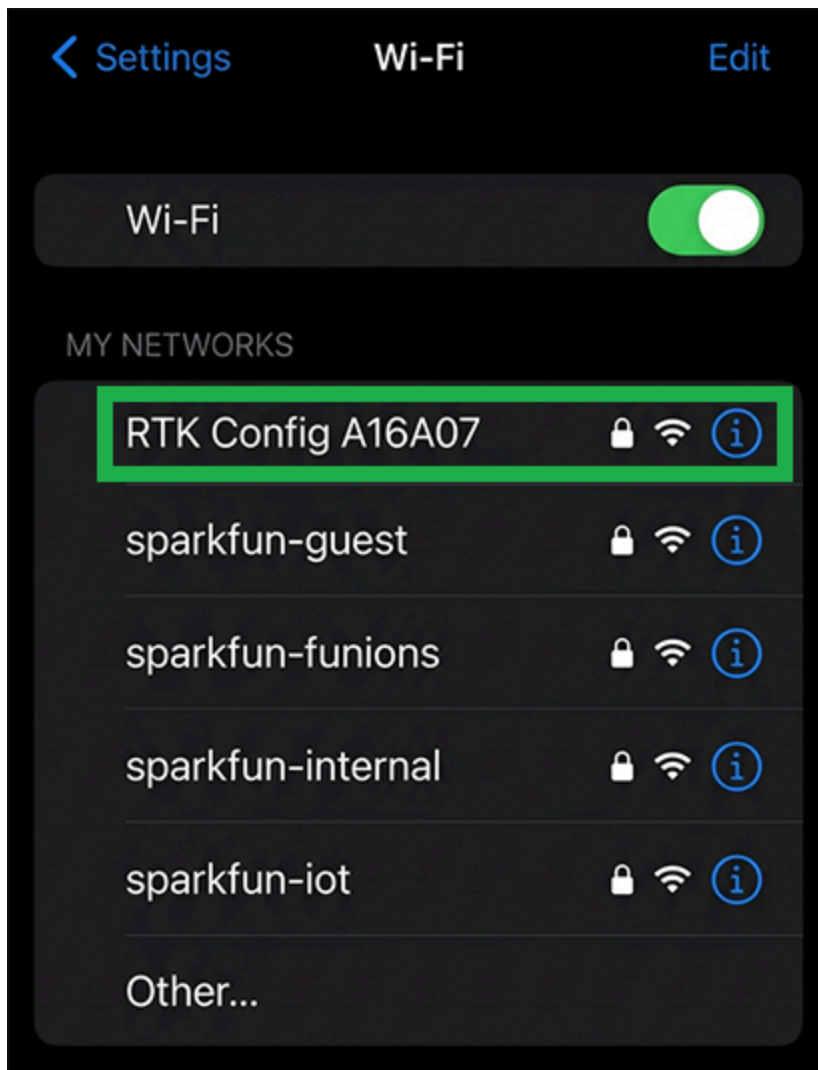

*Connecting from an iOS device.*

**⚠ WARNING**

If you have problems, try disabling mobile/cellular data on your mobile device. The device or browser might be using the cellular connection for its internet access; however, we want to disable this setting to ensure that your mobile device remains on the WiFi access point for the browser.

4. Once the browser is opened, you should be automatically re-directed to the configuration webpage. If not, open a browser (Chrome is preferred) and type `http://rtk.local` into the address bar.

```
https://rtk.local/
```



http://rtk.local/



# SPARK PNT DEVICE SETUP



Model: TX2  
RTK Everywhere Firmware: v3.2  
LG290P Firmware: LG290P03AANR02A01S ID: 000018A5DA5A8D19  
Device Bluetooth ID: E61E07  
LLh: 0.00000000, 0.00000000, 0.000 (APC)  
ECEF: 6378137.000, 0.000, 0.000

Profile Configuration ▾

GNSS Configuration ▾

Base Configuration ▾

PointPerfect Configuration ▾

Ports Configuration ▾

WiFi Configuration ▾

TCP / UDP Configuration ▾

Radio Configuration ▾

Corrections Configuration ▾

Instrument Configuration ▾

System Configuration ▾

Save Configuration 

Exit and Reset 

Browser with `rtk.Local` webpage.

# Modes of Operation

The FPX functions in a variety of modes:

- GNSS Positioning (~700mm accuracy) - also known as **Rover**
- GNSS Positioning with RTK (8mm accuracy) - using a local base station
- GNSS Positioning with PPP-RTK (14 to 60mm accuracy) - using PointPerfect corrections
- GNSS Base Station
- GNSS Base Station as NTRIP Server
- To start recording surveying positions, simply open your preferred GIS app on any smartphone or tablet, pair the FPX as a BLE device, and access your NTRIP corrections service using the internet/cellular connection of your mobile device. With its MFi certification, users can now pair our SparkPNT devices with any Apple's iOS device!
  - With Galileo HAS corrections enabled by default on the FPX, users don't even need an NTRIP correction service. Just wait 8-15 min. for the FPX to reach a convergence point in its position corrections, then begin recording positions with <20cm (<8") of precision. This option is great for remote locations with limited access to data, internet, or cellular services. While it is free and has global coverage, the performance of this PPP based service is limited by several factors.
- The SparkPNT FPX can also operate as a base station, to broadcast RTK corrections and function as an NTRIP caster/server.
  - In scenarios where only precision measurements are required and not the accuracy of the global position, users can setup their base station in a few minutes using our **Base Assist** function. In this mode, the FPX averages a set of basic GNSS measurements to record its base station position before broadcasting RTK corrections. This option is great for recording precision measurements that only need to maintain accuracy relative to each other; and not their global position in reference to the Earth. For example, if you only need to survey the footprint of a building or intersection; or in situations where there are reference markers that can be used to adjust your measurements with post-processing.

- For all other applications, where the accuracy of the global positions are critical, users have two options to setup their base station.
  - Use a known, reference or survey mark to setup the base station.
  - Survey-in the base, setup the base station and record positions over an extended period of time to determine its position. The accuracy of this, is directly correlated to the length of time spent during this process. For additional accuracy, the raw GNSS signal data can be recorded and submitted through a online PPP (Precise Point Position) post-processing service ([NRCAN](#) or [OPUS](#))

## Rover

In **Rover** mode, the FPX will receive L1, L2, and L5 GNSS signals from the four constellations (GPS, GLONASS, Galileo, and BeiDou) and output the devices' position with accuracies around 700mm. The device will calculate the position based on the combination of GNSS and any correction signals (primarily SBAS, if available). Similar to a standard-grade GNSS receiver, the FPX will output industry standard NMEA sentences at 2Hz and can broadcast them to any paired Bluetooth® device. The end user will need to parse the NMEA sentences using [commonly available mobile apps](#), [GIS products](#), or embedded devices (there are many open source libraries).

## Rover with RTK

In **Rover with RTK** mode, the FPX will receive GNSS signals and combine them with RTCM correction data to achieve accuracy of approximately 8mm horizontal positional accuracy and 15mm vertical accuracy. The RTCM correction data is most easily obtained over a cellular connection to the Internet using a free app on your phone (see [SW Maps](#) or [Lefebure NTRIP](#)) and sent over Bluetooth®. Additionally, corrections can be obtained over WiFi, or [ESP-NOW](#). Correction data can come from 2nd unit setup as a base station, from a free local base station, or from a paid service. See the [Quick Start guide](#) and the [NTRIP Client](#) for more information.

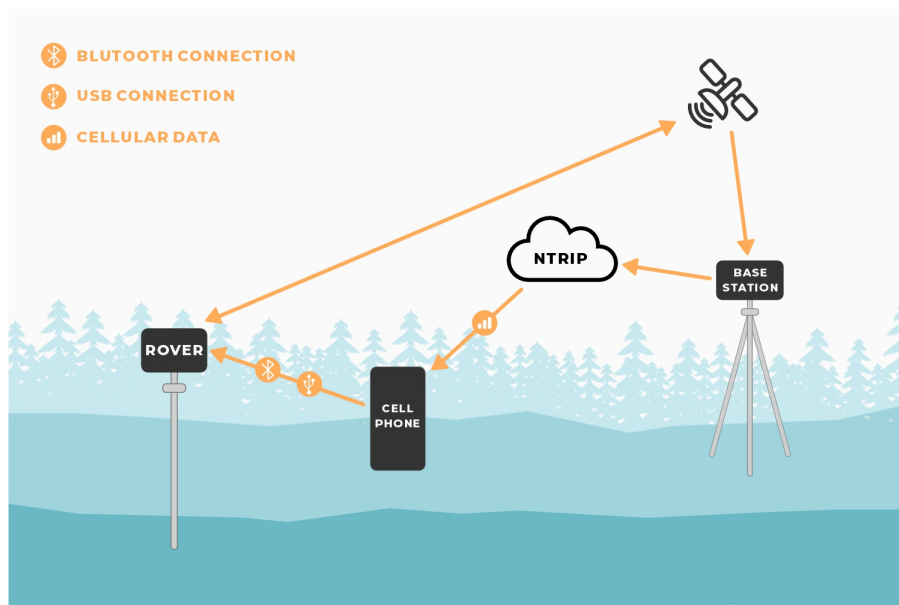

*The device connectivity for RTK corrections from an NTRIP network.*

## Rover with PPP-RTK

In **Rover with PPP-RTK**, the FPX will receive GNSS signals and combine them with correction data provided over an IP connection (usually a cell phone hotspot). The corrections are State Space Representation (SSR) based and are also known as PPP-RTK. These corrections are obtained from [ublox's PointPerfect network](#). Time to RTK Fix can take up to 300 seconds and has 14 to 60mm horizontal positional accuracy.

## Base Station

In **Base Station** mode the device is mounted to a fixed position (like a tripod or roof) and will initiate a survey. After 60 to 120 seconds the survey will complete and the FPX will begin transmitting RTCM correction data over the built in 2.4GHz radio (if [ESP-NOW](#) is enabled). A base is often used in conjunction with a second FPX unit (or [RTK Facet](#), [RTK Surveyor](#), [Express](#), [Express Plus](#), etc) set to `Rover` to obtain the 8mm accuracy. Said differently, the Base sits still and sends correction data to the Rover so that the Rover can output a really accurate position. The relative accuracy of this mode is 8mm base-to-rover but has higher (up to a meter) of absolute inaccuracy. See [how to set up a permanent base](#) to decrease the absolute inaccuracy.

## Base Station with NTRIP

In **Base Station with NTRIP** the device will enter Base Station mode. If WiFi is available, and the **NTRIP Server(s)** is enabled, its corrections will be broadcast to up to four NTRIP casters and made available to any rover that also has internet access and is within 10-20km.

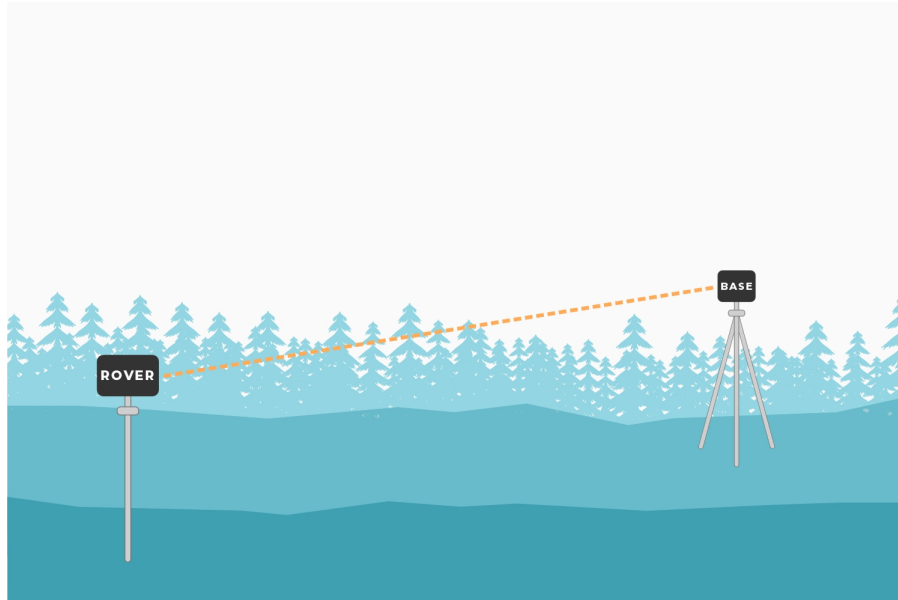

*The device connectivity for RTK corrections from an base station.*

# Corrections Services

Users can pro

## Priorities

To achieve an RTK Fix, SparkPNT products must be provided with a correction source. An RTK device can obtain corrections from a variety of sources. Below is the list of possible sources (not all platforms support all sources) and their default priorities. These defaults generally follow the rule that a shorter baseline between Rover and Base leads to more accurate, and therefore more valuable, correction data:

- External Radio (100m OSR Baseline) - Two packet radios communicating directly between a Rover and Base
- ESP-NOW (100m OSR Baseline) - Two RTK devices communicating directly between a Rover and Base over the built-in 2.4GHz radios
- LoRa Radio (1km OSR Baseline) - Two RTK devices communicating directly between a Rover and Base over the built-in LoRa radios (RTK Torch only)
- Bluetooth (10+km OSR/SSR Baseline) - A Rover obtaining corrections over Bluetooth to a phone/tablet that has an NTRIP Client
- USB (10+km OSR/SSR Baseline) - A Rover obtaining corrections over USB to a phone/tablet that has an NTRIP Client
- TCP (NTRIP) (10+km OSR/SSR Baseline) - A Rover obtaining corrections over WiFi to a NTRIP Caster
- L-Band (100km SSR Baseline) - A Rover obtaining corrections from a geosynchronous satellite
- IP (PointPerfect/MQTT) (100+km SSR Baseline) - A Rover obtaining corrections from an SSR type correction service over WiFi or cellular

The *Corrections Priorities* menu allows a user to specify which correction source should be given priority. For example, if corrections are provided through ESP-NOW and IP PointPerfect simultaneously, the corrections from IP PointPerfect will be discarded because the ESP-NOW source has a higher priority. This prevents the RTK engine from receiving potentially mixed correction signals.

In the web config page:

- Clicking a source increases its priority
- Clicking the highest priority source makes it the lowest priority
- Clicking `Reset to Defaults` will restore the priorities to their default setting
- Click `Save Configuration`, then `Exit and Reset` to save the changes

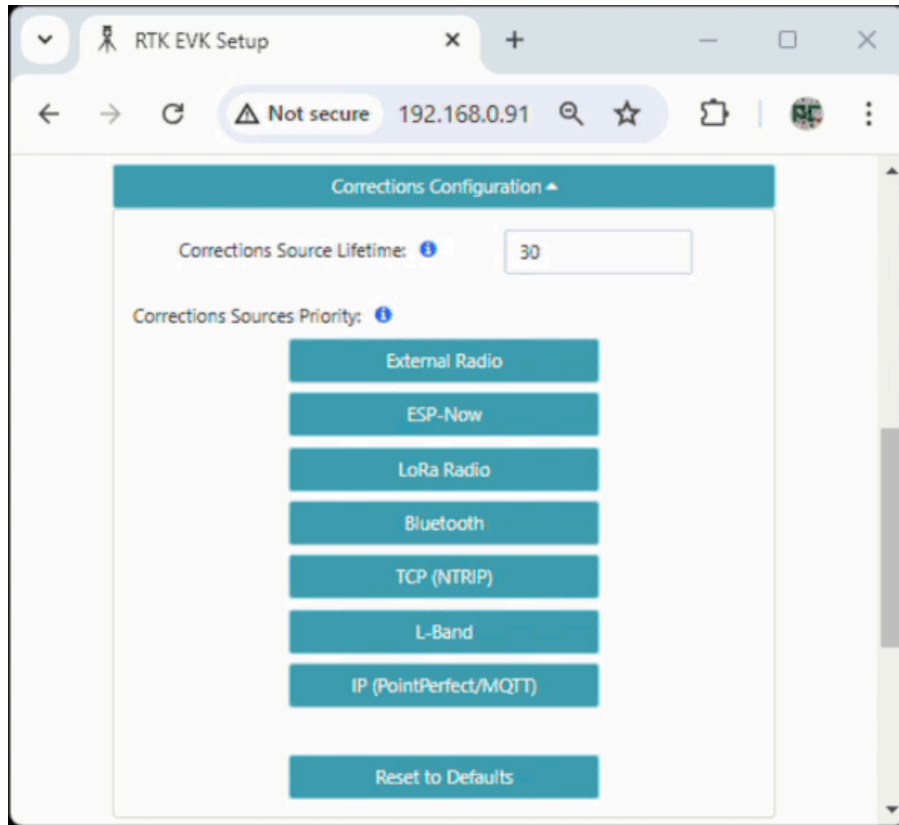

Please see [Correction Sources](#) section of the RTK Everywhere Firmware manual for a description of how to obtain corrections.

# Configuration Settings

## WARNING

Users can only select, create/rename, or configure the settings of one profile at a time. Users cannot perform more than one of these tasks or perform these tasks on multiple profiles.

- A profile can be created or renamed
  - Select a different profile
  - Configure the settings of a selected profile
  - Reset the selected profile to its default configuration
1. Once a one of these tasks (*listed above*) has been performed for a single profile. If a configuration setting has been changed, users must save the settings and reload the webpage.
    - i. Users must click the **Save Configuration** button.
    - ii. Once the **Success : All Saved** message appears, the webpage needs to be reloaded.
  2. Refresh the webpage to load the selected profile or saved configuration settings.
    - Alternatively, users can also reset the device by clicking the **Exit and Reset** button.
  3. Only after the webpage reloaded (*the device has been reset*), should users proceed with another of the tasks listed above.

## Profiles

From the **rtk.local** configuration webpage, open the **Profile Configuration** drop-down menu. Users can store up to eight profiles, with user-specified names. This is handy for saving multiple device configurations for various tasks and/or end-users.

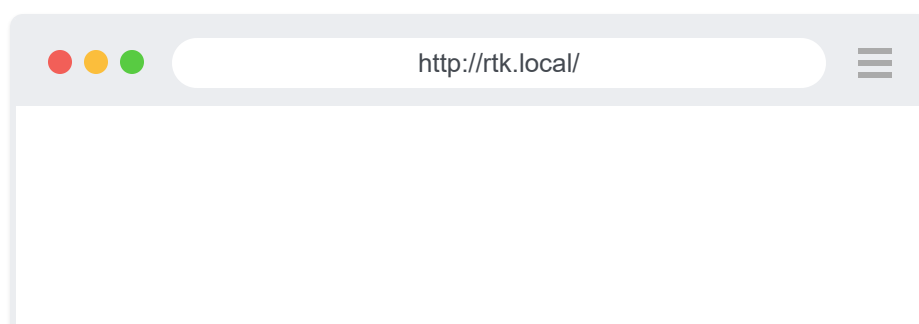

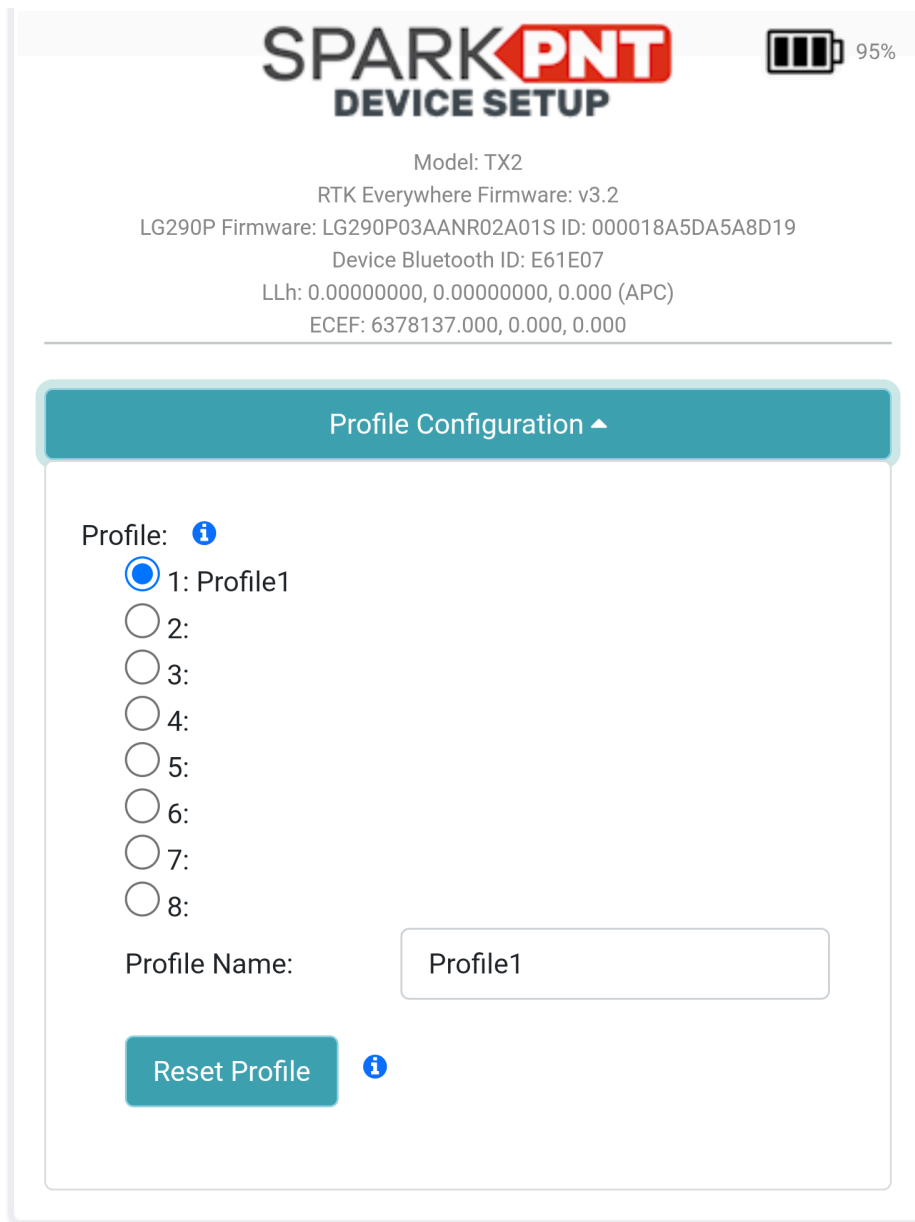

The `Profile Configuration` menu.

## Create or Rename Profile

Select a bullet, then enter a new name in the **Profile Name:** `text box`.

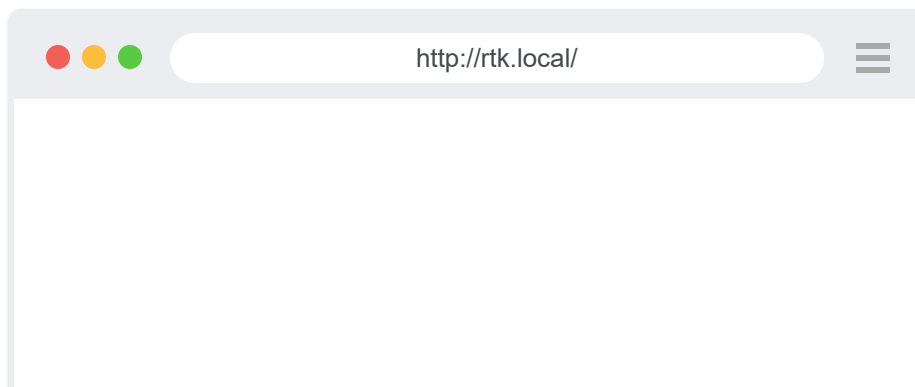

**SPARK PNT**  
DEVICE SETUP

Model: TX2  
RTK Everywhere Firmware: v3.2  
LG290P Firmware: LG290P03AANR02A01S ID: 000018A5DA5A8D19  
Device Bluetooth ID: E61E07  
LLh: 0.00000000, 0.00000000, 0.000 (APC)  
ECEF: 6378137.000, 0.000, 0.000

93%

Profile Configuration ▲

Profile: ⓘ

1: Profile1  
 2:  
 3:  
 4:  
 5:  
 6:  
 7:  
 8:

Profile Name:

Reset Profile ⓘ

*Naming the second profile slot to `test`.*

Scroll to the bottom of the configuration webpage and click the `Save Configuration` button. Once the `Success : All Saved` message appears, reload the webpage to update the configuration settings. With the webpage refreshed, open the `Profile Configuration` menu; the second profile should be selected and named `test`.

## Configure a Profile

Changing the settings of a profile is relatively straight forward, once the profile has been loaded properly on the webpage.

1. Select the bullet of the profile you'd like to configure.

- Under the `Profile Name:` section of the menu, a `Loading. Please wait...` message will appear.
2. Give the device ~10 seconds to load the profile, then refresh the webpage.
  3. Open the `Profile Configuration` menu to verify that the proper profile is selected.

 **TIP**

- i. If the selected profile hasn't loaded the device may need more time to load all the setting. Give it a minute before refreshing the webpage.
- ii. If the selected profile still hasn't loaded, users may need to manually reset the device and starting over.

4. Once users have verified that the profile has loaded properly, scroll down to change any of its configuration settings.

After the desired settings have been changed, scroll to the bottom of the configuration webpage and click the `Save Configuration` button. Once the `Success : All Saved` message appears, reload the webpage to update the configuration settings for the selected profile.

## Reset a Profile

Users can reset a profile to the device's factory settings. Select the profile from the menu, then click on the `Reset Profile` button.

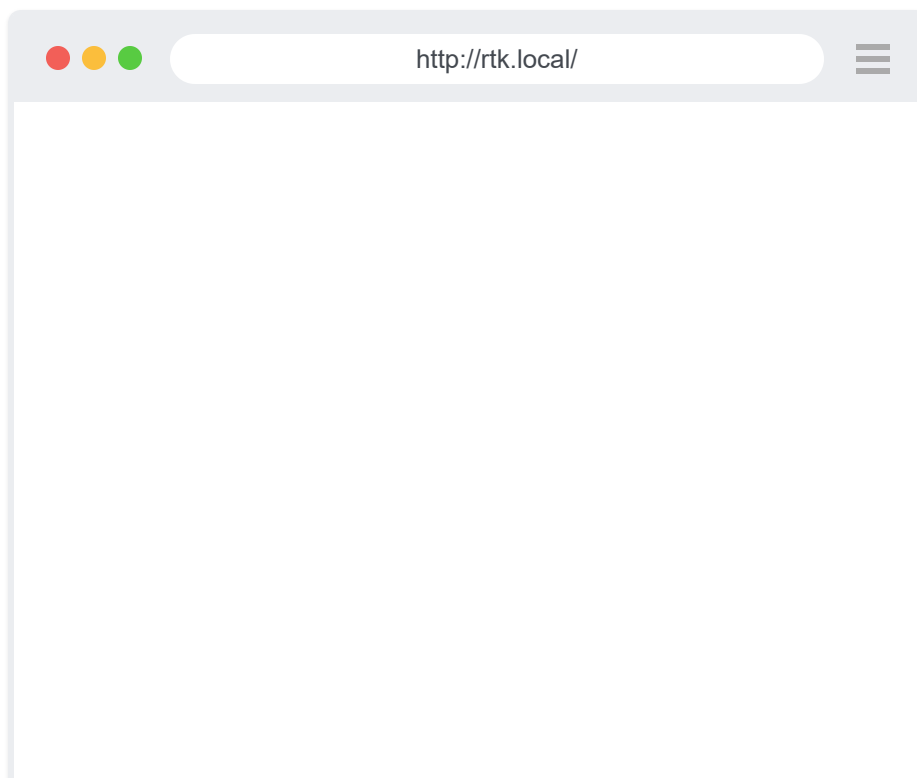

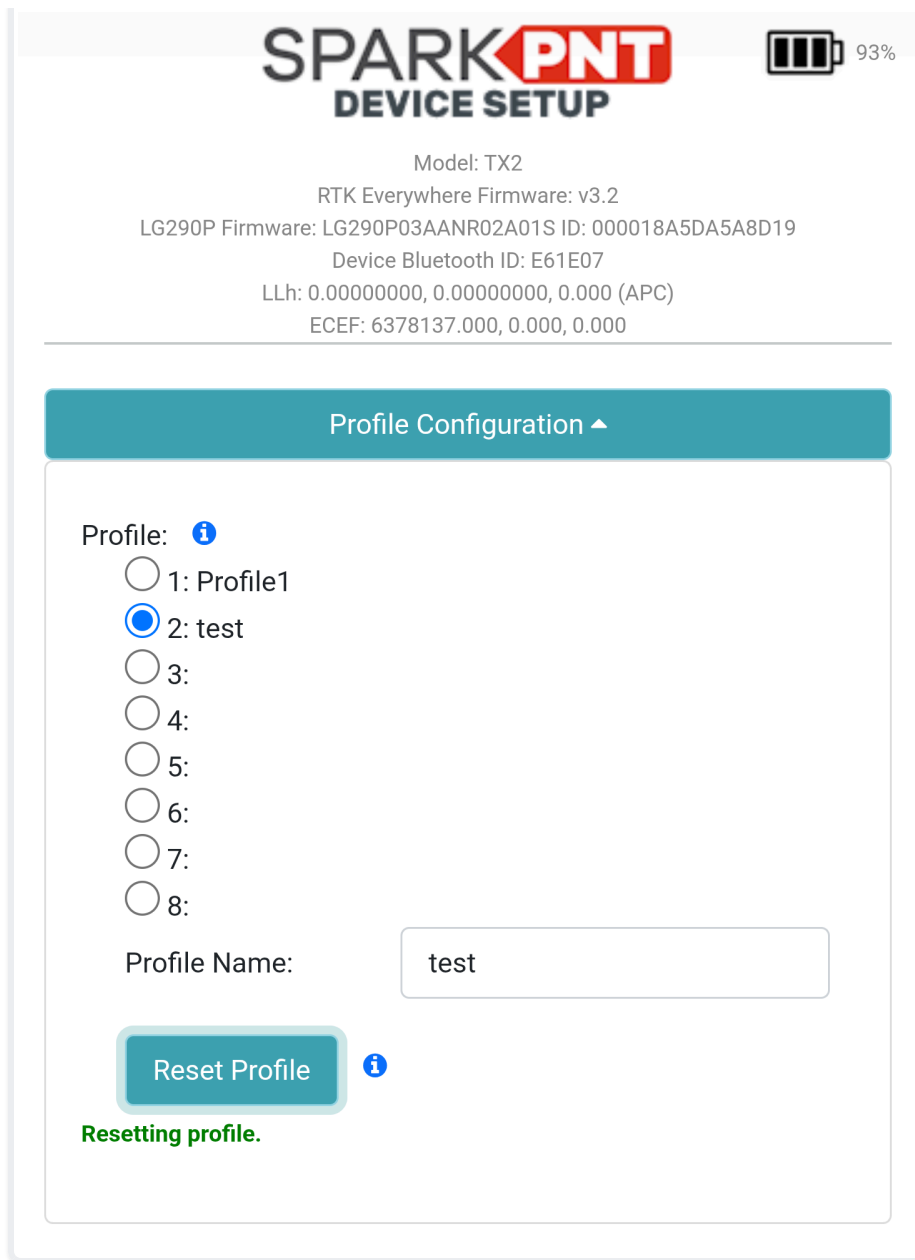

*Resetting the second profile slot.*

A `Resetting profile.` message will appear briefly. Once it has vanished, scroll to the bottom of the configuration webpage and click the `Save Configuration` button. Once the `Success : All Saved` message appears, reload the webpage to update the configuration settings.

 **TIP**

The selected profile should appear blank, without a name. If the profile appears with the name `123456798...`, wait ~5 seconds and reload the webpage again.

# GNSS and Rover Settings

From the [rtk.local](http://rtk.local) configuration webpage, open the **GNSS Configuration** drop-down menu. Here, users can change the settings for the GNSS receiver and the settings for operating as a **rover**; including, but not limited to the GNSS constellations utilized, the GNSS messages and solution data rates, elevation masks, the signal to noise ratio mask ( $C/N_0$ ), PPP services and settings, and/or NTRIP client and settings.





Model: TX2  
RTK Everywhere Firmware: v3.2  
LG290P Firmware: LG290P03AANR02A01S ID: 000018A5DA5A8D19  
Device Bluetooth ID: E61E07  
LLh: 0.00000000, 0.00000000, 0.000 (APC)  
ECEF: 6378137.000, 0.000, 0.000

## Profile Configuration ▾

## GNSS Configuration ▲

### Measurement Rate:

In Hz: 

or

Seconds between measurements: 

Min SV Elevation: 

Min C/N0: 

Constellations: 

BeiDou

Galileo

GLONASS

GPS

NAVIC

QZSS

PPP Service: 

Datum:  

Timeout: 

Horizontal Convergence:  ⓘ

Vertical Convergence:  ⓘ

MSM7 RTCM Selection ⓘ

Min SV Elevation for RTCM:  ⓘ

Enable NTRIP Client ⓘ

ⓘ

The `GNSS Configuration` menu.

After the desired settings have been changed, scroll to the bottom of the configuration webpage and click the `Save Configuration` button. Once the `Success : All Saved` message appears, reload the webpage to update the configuration settings.

## Base Station

From the `rtk.local` configuration webpage, open the `Base Configuration` drop-down menu. Here, users can configure the settings for operating as a `base station`. Additionally, users can enable the device to function as an `NTRIP server` and and configure the RTCM messages for RTK corrections.

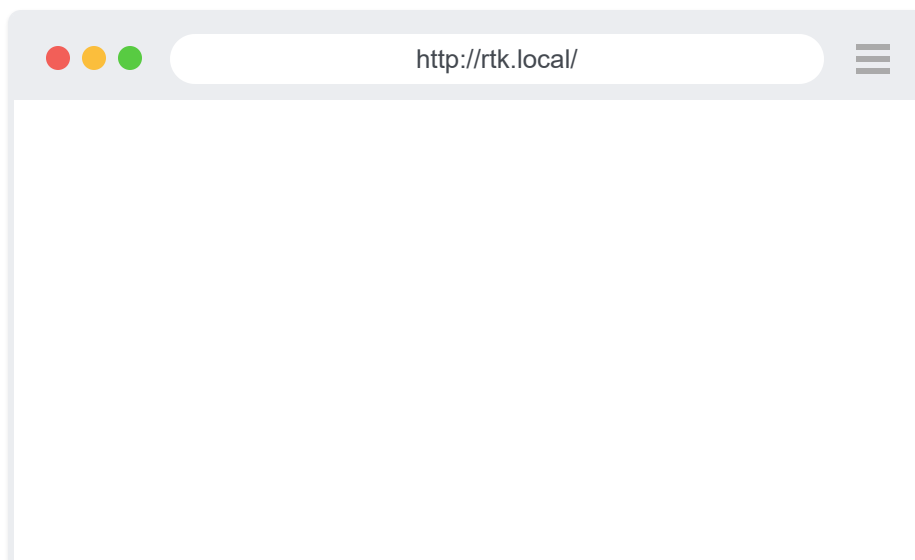

# SPARK PNT

## DEVICE SETUP

 95%

Model: TX2  
RTK Everywhere Firmware: v3.2  
LG290P Firmware: LG290P03AANR02A01S ID: 000018A5DA5A8D19  
Device Bluetooth ID: E61E07  
LLh: 0.00000000, 0.00000000, 0.000 (APC)  
ECEF: 6378137.000, 0.000, 0.000

---

Profile Configuration ▾

GNSS Configuration ▾

Base Configuration ▲

Survey-In i

Minimum observation time (s):

60

Required Mean 3D Standard Deviation (m):

5.00

Fixed (Choose ECEF or Geodetic) i

Enable NTRIP Server i

RTCM Rates ▾ i

The Base Configuration menu.

The base station's location can be provided with two methods, which affect the absolute-accuracy of its RTK corrections:

- **Fixed:** Users can provide a fixed position for the base station's location in [ECEF] or [geodetic] coordinates. This is used to provide RTK corrections to rovers, for the most accurate surveying results in relation to fixed coordinates on the planet Earth.

- For example, surveying property lines, locating or installing utilities, or other applications where the accuracy of measured positions must be repeatable.
- **Survey-In:** The base station configures its location, based on an average of measurements made over a specified time frame. This is used to provide RTK corrections where the absolute-accuracy of a rover's position isn't necessary and relative-accuracy of its measurements are sufficient.
  - For example, aerial surveys, mapping trails and campsites, or drafting construction plans where the accuracy of measurements in relation to one another (*i.e. relative-accuracy*) is important. However, the location of those positions, in relation the planet Earth (*i.e. absolute-accuracy*) is irrelevant.

**! INFO**

Any errors in the base station's location, are propagated directly into the rover through the RTK corrections. Therefore, if the base station is off by 2m in a specific direction; all the RTK measurements from a rover, using that base station, will also be off by 2m in the exact same direction.

After the desired settings have been changed, scroll to the bottom of the configuration webpage and click the `Save Configuration` button. Once the `Success : All Saved` message appears, reload the webpage to update the configuration settings.

## Point Perfect Service

From the `rtk.local` configuration webpage, open the `Point Perfect Configuration` drop-down menu. If users have an active subscription, they can enable their Point Perfect service here.

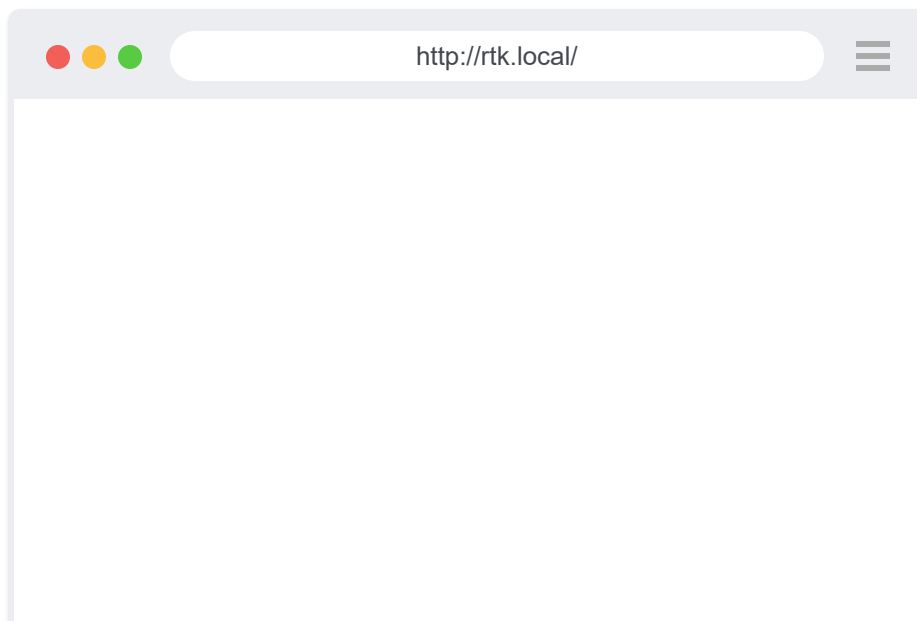

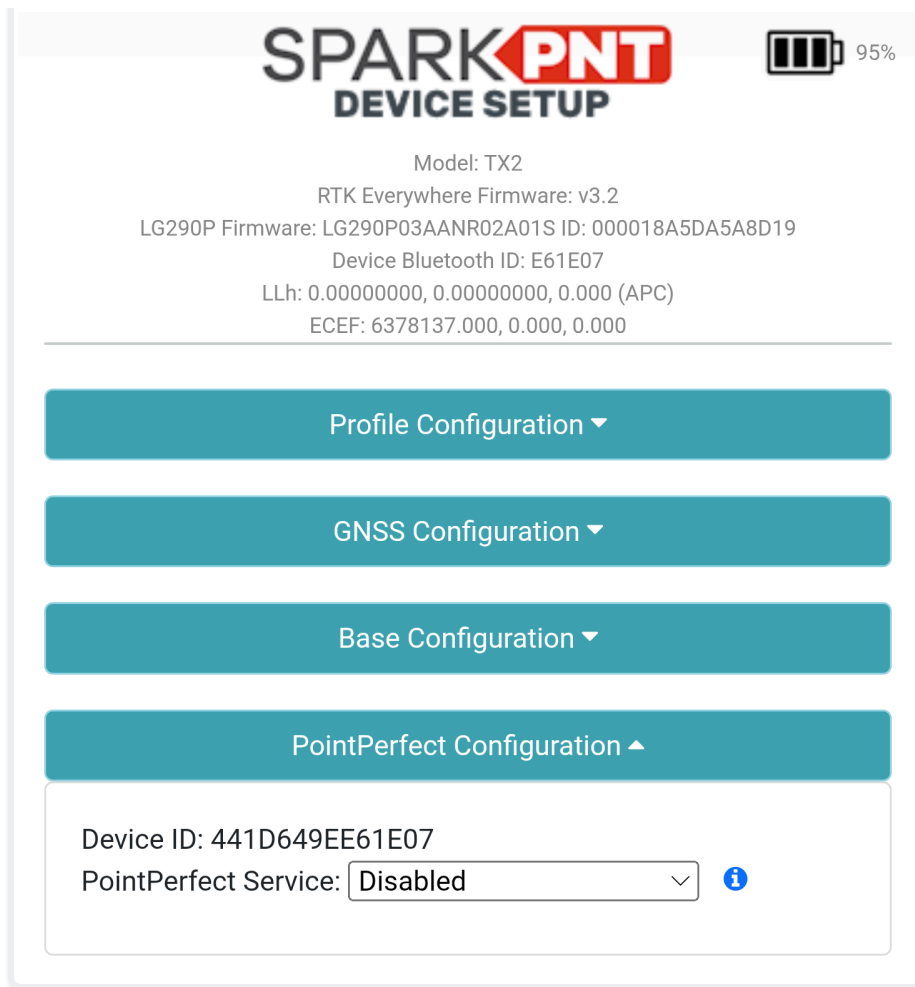

The `Point Perfect Configuration` menu.

After the desired settings have been changed, scroll to the bottom of the configuration webpage and click the `Save Configuration` button. Once the `Success : All Saved` message appears, reload the webpage to update the configuration settings.

## Data Ports

From the `rtk.local` configuration webpage, open the `Ports Configuration` drop-down menu. This allows users to enable and configure data outputs on the following ports. For the FPX, this is limited to the USB-C port.

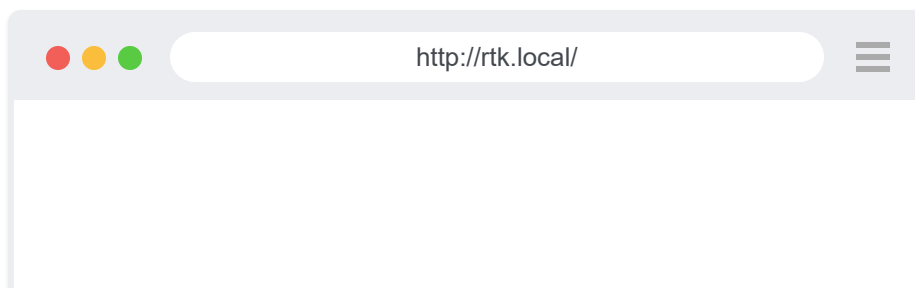

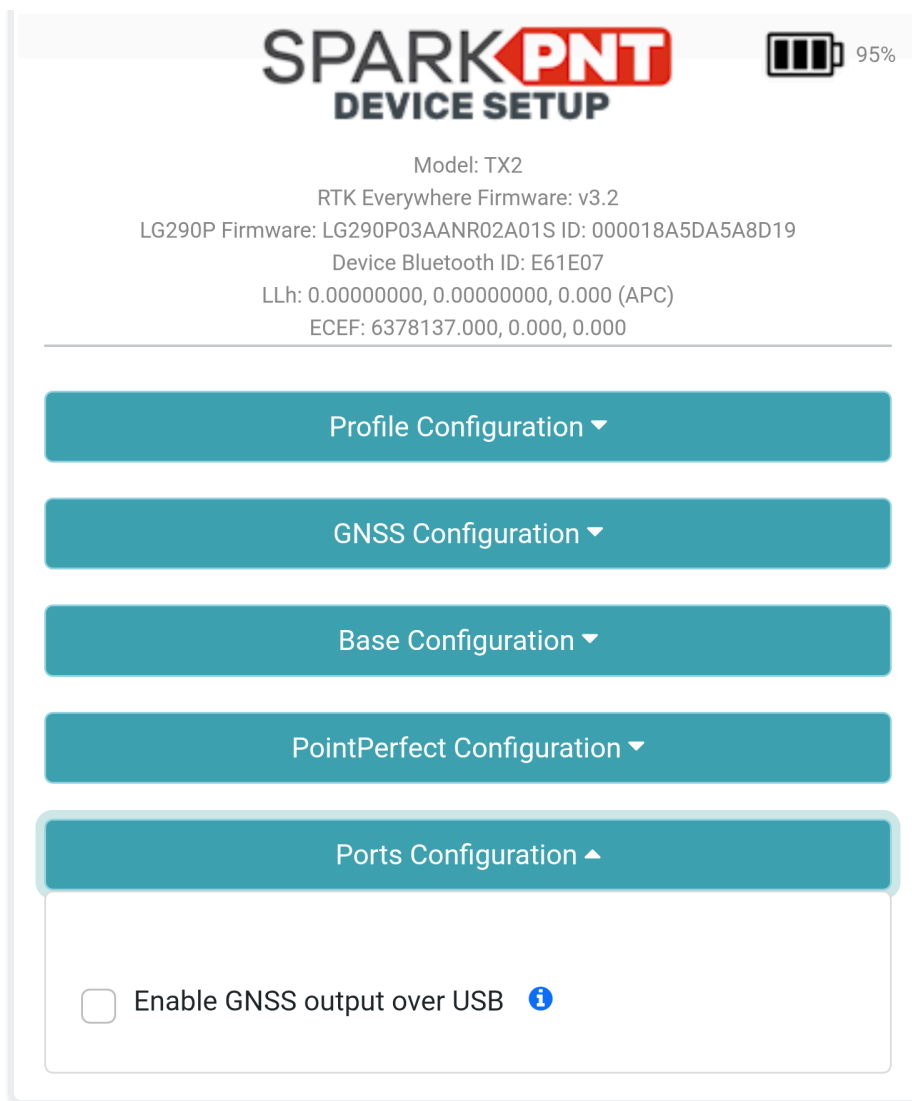

The `Ports Configuration` menu.

After the desired settings have been changed, scroll to the bottom of the configuration webpage and click the `Save Configuration` button. Once the `Success : All Saved` message appears, reload the webpage to update the configuration settings.

## WiFi Connection

From the `rtk.local` configuration webpage, open the `WiFi Configuration` drop-down menu. Here users can configure the WiFi setting of the device. The device has two operational modes:

- **AP:** The device provides a WiFi access point for other devices to connect to it. This is useful for configuring the device in remote locations, where a WiFi network is not available.
- **WiFi:** The device access the WiFi networks configured in its settings. This is useful for connecting to WiFi hotspots (provided by a cellular device) for NTRIP services; or using a local WiFi network

to configure settings and/or update the firmware for theFPX.

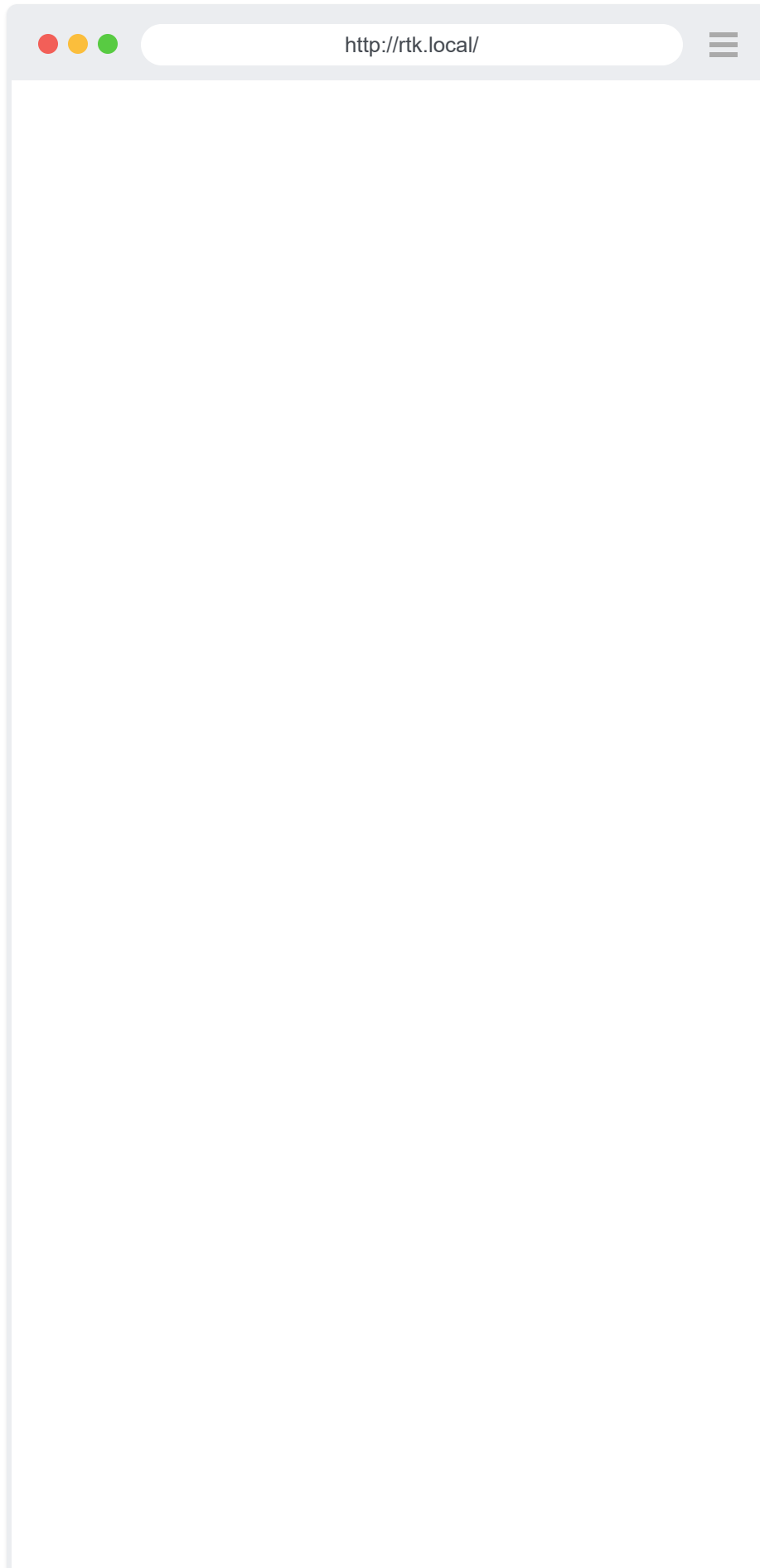

Model: TX2  
RTK Everywhere Firmware: v3.2  
LG290P Firmware: LG290P03AANR02A01S ID: 000018A5DA5A8D19  
Device Bluetooth ID: E61E07  
LLh: 0.00000000, 0.00000000, 0.000 (APC)  
ECEF: 6378137.000, 0.000, 0.000

Profile Configuration ▾

GNSS Configuration ▾

Base Configuration ▾

PointPerfect Configuration ▾

Ports Configuration ▾

WiFi Configuration ▲

Networks: 

SSID 1:

PW 1:

SSID 2:

PW 2:

SSID 3:

PW 3:

SSID 4:

PW 4:

Configure Mode:  ▾ 

The WiFi Configuration menu.

After the desired settings have been changed, scroll to the bottom of the configuration webpage and click the **Save Configuration** button. Once the **Success : All Saved** message appears, reload the webpage to update the configuration settings.

## WiFi Mode

At the bottom of the **WiFi Configuration** menu, there are two WiFi modes the users can select:

- **AP**: The device will broadcast an access point called **RTK Config** that allows users to access this configuration webpage.
- **WiFi**: The device will try to connect to the WiFi networks, configured in the settings of the **WiFi Configuration** menu.
  - To reconfigure the device back into **AP** mode, users will need to connect to the same WiFi network as the device. Once connected, open a browser and users should be able to access the [rtk.local](http://rtk.local) configuration webpage.

After the desired settings have been changed, scroll to the bottom of the configuration webpage and click the **Save Configuration** button. Once the **Success : All Saved** message appears, reload the webpage to update the configuration settings.

## WiFi Networks

In the **WiFi Configuration** menu, users can save up to four WiFi network connections. Just select and enter/modify the credentials for each WiFi network.

### INFO

The FPX is only compatible with 2.4GHz WiFi networks, which have more range. It cannot connect to the higher bandwidth/speed 5GHz networks. This is a hard limitation of this device and is not upgradable through software or hardware.

### TIP

For connections to Apple iOS devices, user will need to modify their [hotspot settings](#).

Once the device has been reset, the device will beep. To allow the device to connect to a WiFi network, double click the (  ) power button. The status indicator will turn solid, once the WiFi

connection has been established.

## TCP/UDP Connection

From the `rtk.local` configuration webpage, open the `TCP/UDP Configuration` drop-down menu.

This allows the device to access or provide corrections using either the TCP or UDP protocols.

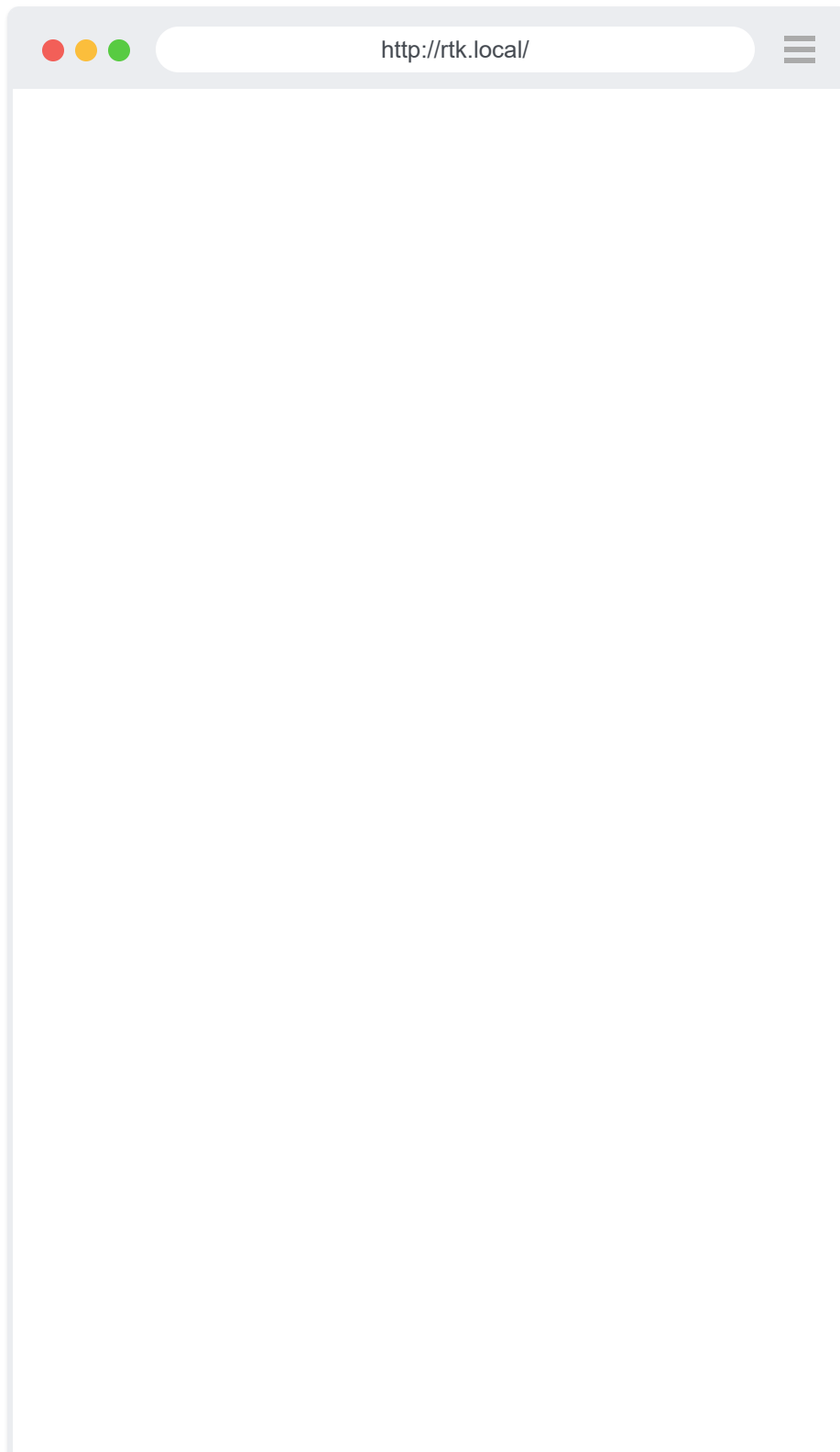

Model: TX2  
RTK Everywhere Firmware: v3.2  
LG290P Firmware: LG290P03AANR02A01S ID: 000018A5DA5A8D19  
Device Bluetooth ID: E61E07  
LLh: 0.00000000, 0.00000000, 0.000 (APC)  
ECEF: 6378137.000, 0.000, 0.000

Profile Configuration ▾

GNSS Configuration ▾

Base Configuration ▾

PointPerfect Configuration ▾

Ports Configuration ▾

WiFi Configuration ▾

TCP / UDP Configuration ▲

TCP Client 

Port: 

2948

Host for TCP  
Client: 

10.10.10.173

TCP Server 

UDP Server 

The **TCP/UDP Configuration** menu.

After the desired settings have been changed, scroll to the bottom of the configuration webpage and click the `Save Configuration` button. Once the `Success : All Saved` message appears, reload the webpage to update the configuration settings.

## Radio Settings

From the `rtk.local` configuration webpage, open the `Radio Configuration` drop-down menu. This setting enables the device to either use the ESP32 or LoRa RF module to broadcast or receive for RTK corrections; including the device pairing configuration.

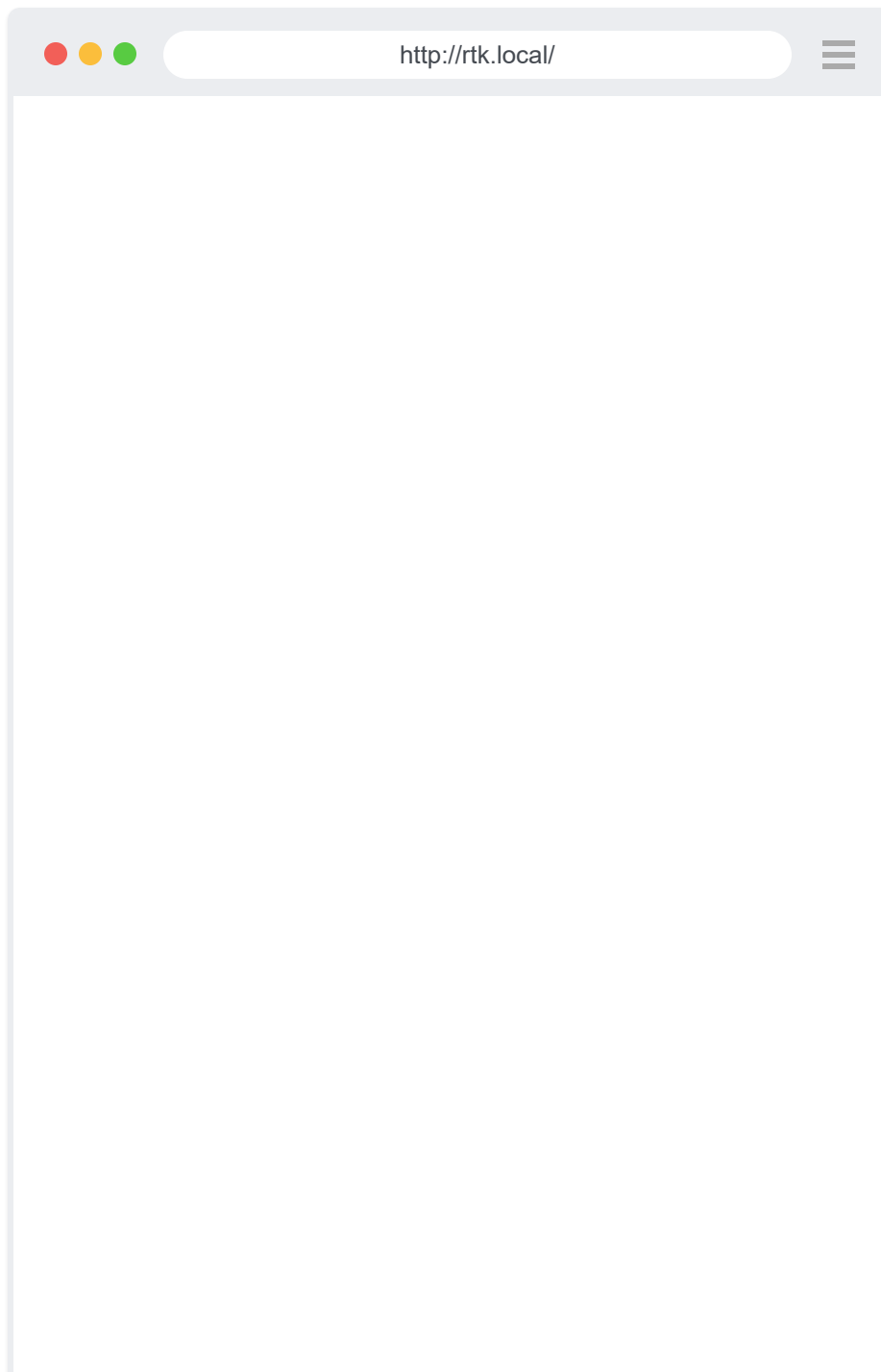

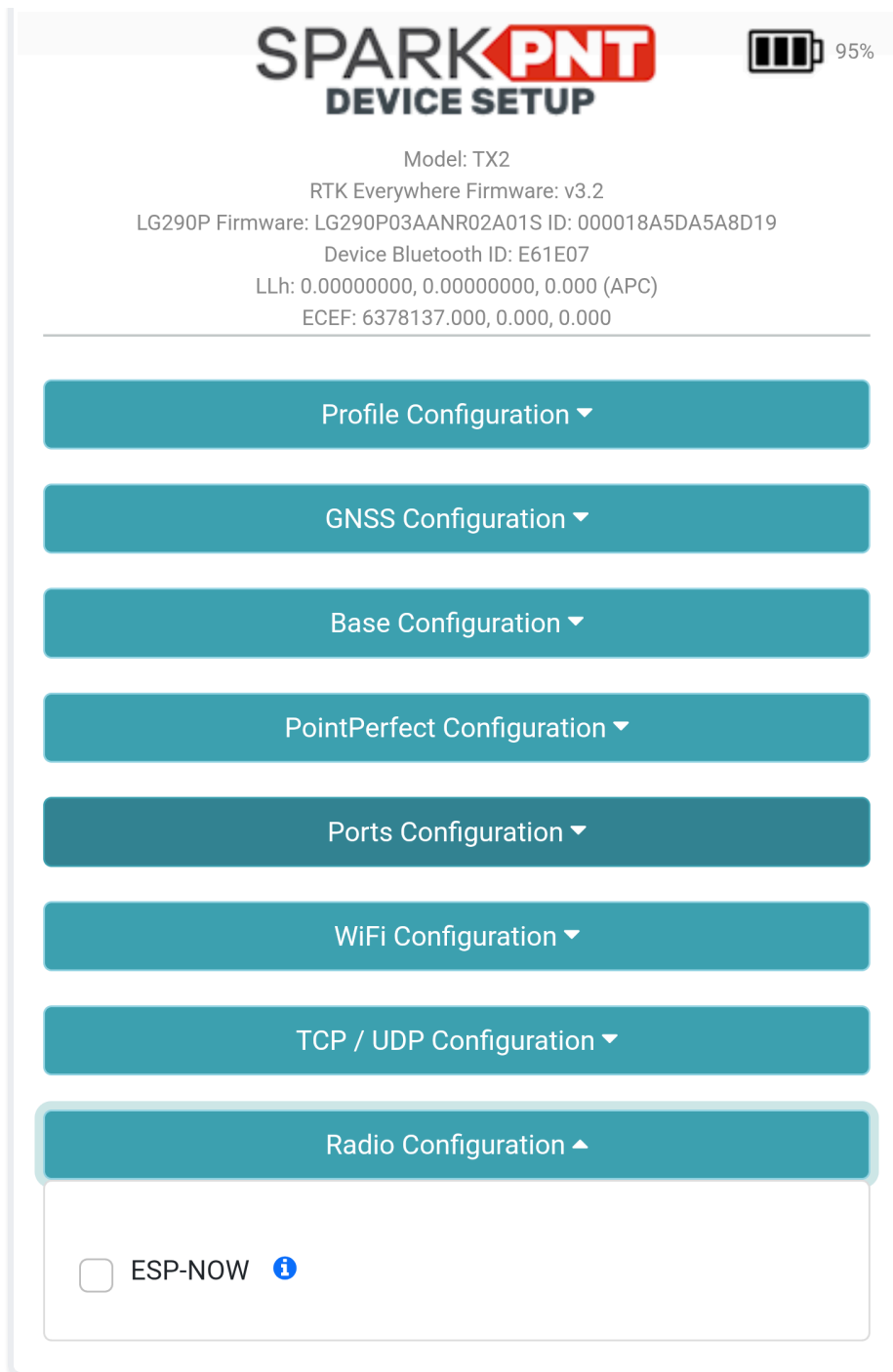

The **Radio Configuration** menu.

After the desired settings have been changed, scroll to the bottom of the configuration webpage and click the **Save Configuration** button. Once the **Success : All Saved** message appears, reload the webpage to update the configuration settings.

## Correction Priorities

From the `rtk.local` configuration webpage, open the `Corrections Configuration` drop-down menu. Selecting any of the available options, will convert it to the first priority.





Model: TX2  
RTK Everywhere Firmware: v3.2  
LG290P Firmware: LG290P03AANR02A01S ID: 000018A5DA5A8D19  
Device Bluetooth ID: E61E07  
LLh: 0.00000000, 0.00000000, 0.000 (APC)  
ECEF: 6378137.000, 0.000, 0.000

Profile Configuration ▾

GNSS Configuration ▾

Base Configuration ▾

PointPerfect Configuration ▾

Ports Configuration ▾

WiFi Configuration ▾

TCP / UDP Configuration ▾

Radio Configuration ▾

Corrections Configuration ▲

Corrections Source Lifetime:



Corrections Sources Priority: 

External Radio

ESP-NOW

LoRa Radio

Bluetooth

USB Serial

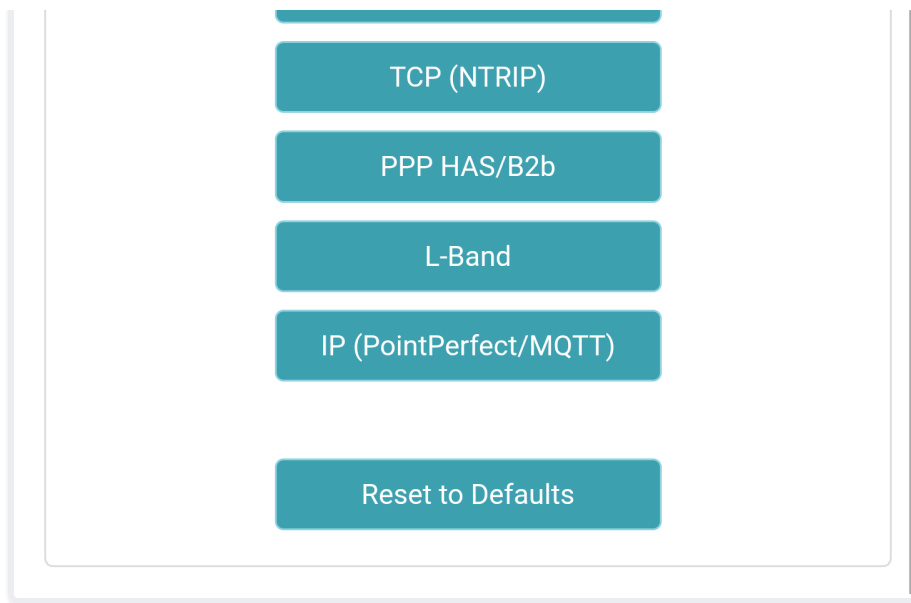

*The `Corrections Configuration` menu.*

After the desired settings have been changed, scroll to the bottom of the configuration webpage and click the `Save Configuration` button. Once the `Success : All Saved` message appears, reload the webpage to update the configuration settings.

## Instrument Heights

From the `rtk.local` configuration webpage, open the `Instrument Configuration` drop-down menu. Here users can configure the APC (antenna phase center) and antenna height for the ARP (antenna reference point), so that measured positions are converted to reference the bottom of the survey pole.

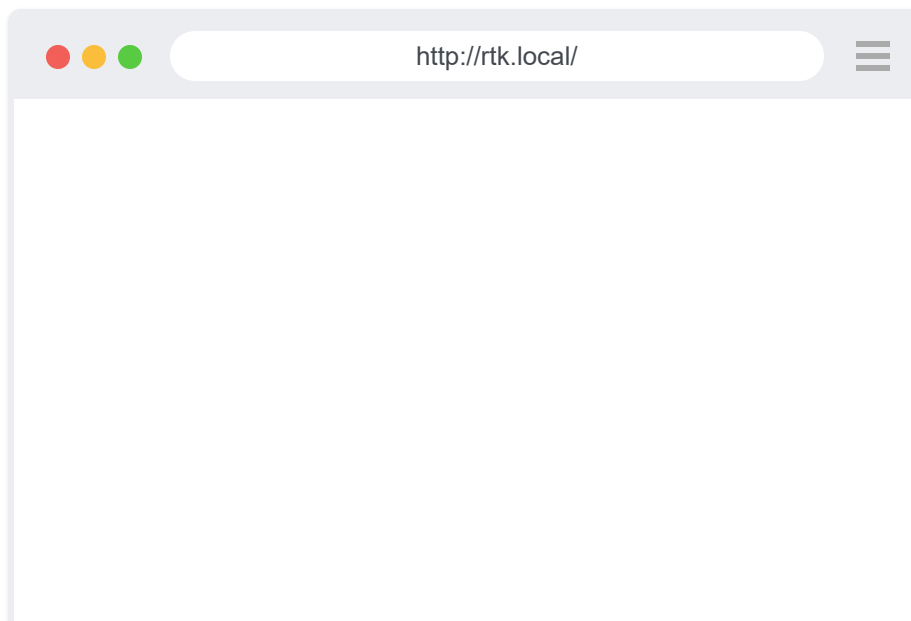

Model: TX2  
RTK Everywhere Firmware: v3.2  
LG290P Firmware: LG290P03AANR02A01S ID: 000018A5DA5A8D19  
Device Bluetooth ID: E61E07  
LLh: 0.00000000, 0.00000000, 0.000 (APC)  
ECEF: 6378137.000, 0.000, 0.000

Profile Configuration ▾

GNSS Configuration ▾

Base Configuration ▾

PointPerfect Configuration ▾

Ports Configuration ▾

WiFi Configuration ▾

TCP / UDP Configuration ▾

Radio Configuration ▾

Corrections Configuration ▾

Instrument Configuration ▲

Antenna Phase Center (mm):



Antenna Height (a.k.a. Pole Length) (m):



The **Instrument Configuration** menu.

There are two provided measurements:

- **APC** (*mm*): This is provided by default for the device. However, users can modify this with calibrated measurements for increased accuracy.
- **Antenna Height** (*m*): This is provided by the user, to convert the measured positions to reference the bottom of a surveying pole. The measurement should be provided in meters, with the length of the surveying pole from its bottom tip to the **ARP (antenna reference point)** of the mounted device.

After the desired settings have been changed, scroll to the bottom of the configuration webpage and click the **Save Configuration** button. Once the **Success : All Saved** message appears, reload the webpage to update the configuration settings.

## System Configuration

From the **rtk.local** configuration webpage, open the **System Configuration** drop-down menu. Here, users can access the devices system settings to upload new firmware, check and update the firmware through a WiFi network, configure its operating modes, the Bluetooth settings, buzzer, units of measurement, and factory reset.

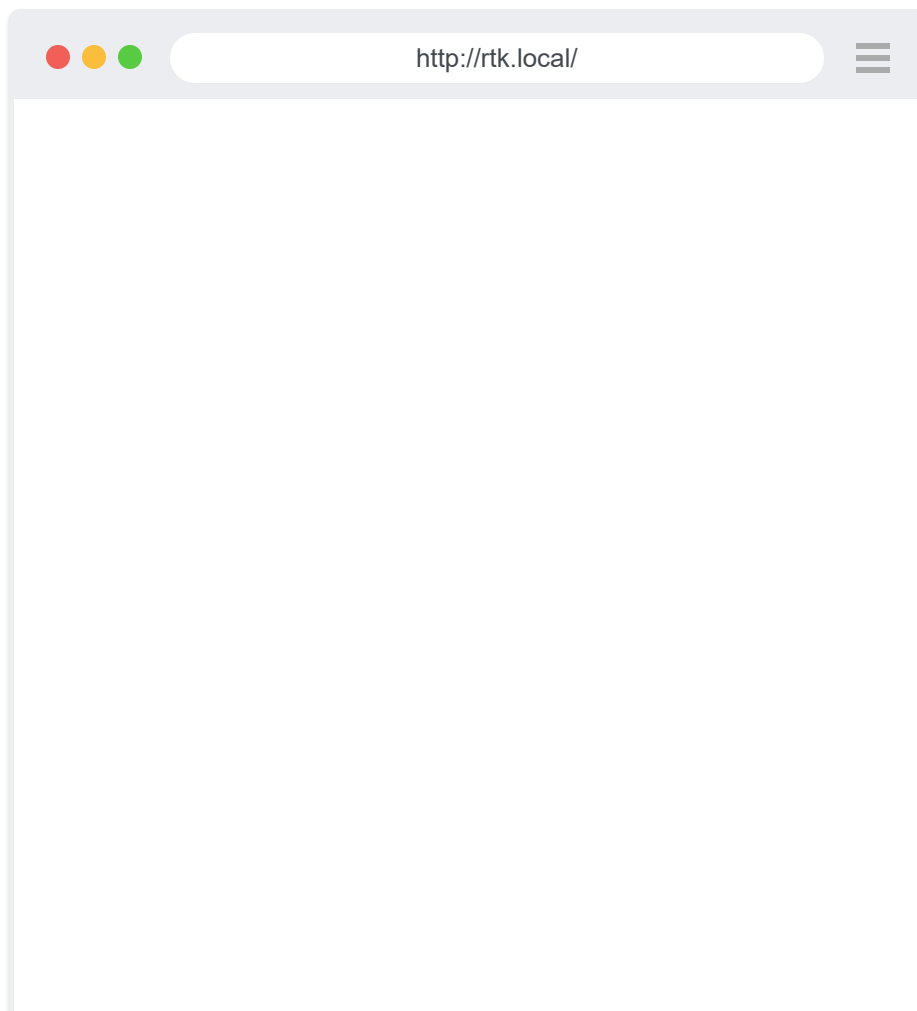



# SPARK PNT DEVICE SETUP

 95%

Model: TX2

RTK Everywhere Firmware: v3.2

LG290P Firmware: LG290P03AANR02A01S ID: 000018A5DA5A8D19

Device Bluetooth ID: E61E07

LLh: 0.00000000, 0.00000000, 0.000 (APC)

ECEF: 6378137.000, 0.000, 0.000

Profile Configuration ▾

GNSS Configuration ▾

Base Configuration ▾

PointPerfect Configuration ▾

Ports Configuration ▾

WiFi Configuration ▾

TCP / UDP Configuration ▾

Radio Configuration ▾

Corrections Configuration ▾

Instrument Configuration ▾

System Configuration ▲

System Firmware: v3.2

[Check for New Firmware](#)



Allow Beta Firmware



Enable Automatic Firmware Updates



[Upload BIN](#)



System Initial State: Rover i

Bluetooth Protocol: SPP & BLE i

Enable Audible Beeper i

Units: Meters i

Enable Automatic Device Restart i

Shutdown If Not Charging i

Enable Factory Defaults i

Reset to Factory Defaults

Save Configuration i

The `System Configuration` menu.

After the desired settings have been changed, scroll to the bottom of the configuration webpage and click the `Save Configuration` button. Once the `Success : All Saved` message appears, reload the webpage to update the configuration settings.

## Firmware Update

There are two methods for [updating the device's firmware](#).

- The [over-the-air method](#), relies on an internet connection from a [WiFi network](#) to check for available updates and download them.
- The [WiFi method](#), is for manually uploading the firmware file from a mobile device. The method relies on the RTK device to be configured as a [WiFi access point](#) for the mobile device to connect to it.

## Factory Reset

Select the `Enable Factory Default` option; then click on the `Reset to Factory Default` button.

A `Defaults Applied. Please wait for device reset...` message will appear next to the button.

The device will beep once, after it has reset. To access the configuration settings again, users will need to [reconnect to the device](#) as an access point (*its default setting*).

# Firmware Updates

There are two firmware components on each device. The [firmware for the GNSS receiver](#) and the [firmware for the device](#).

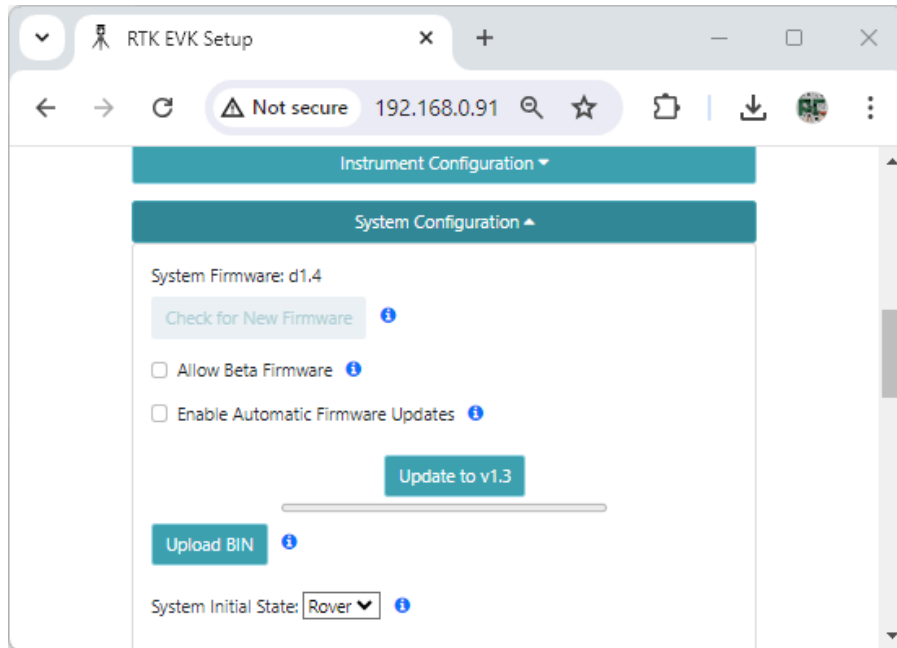

*The RTK EVK Web Config page - firmware update*

SparkPNT will release new firmware to add and improve functionality for users. The firmware can be upgraded through an internet connection using the [OTA method](#). However, this does require that a WiFi connection be configured on the device.

The Firmware Update menu allows users to check for and install updates. Turning on *Automatic firmware updates* will cause the device to periodically check and install updates when they become available. This can be helpful for remote stations that cannot have manual interventions.

## Updating ESP32 Firmware

The ESP32 firmware is the main firmware in all RTK devices. The firmware version number is displayed in a variety of places:



*WiFi Config page showing device firmware v2.7 and ZED-F9P firmware HPG 1.32*

The firmware is shown at the top of the WiFi config page.

From time to time new versions of the RTK Everywhere firmware are released to update functions or add new features. For most users, firmware can be upgraded over WiFi using the OTA method.

- **OTA Method:** Connect over WiFi to download the latest firmware *over-the-air*. This can be done using the WiFi AP Config Mode, but also requires a local WiFi network.
- **WiFi Method:** Load the firmware over WiFi when the device is in WiFi AP Config Mode.

## Updating Firmware Over-The-Air

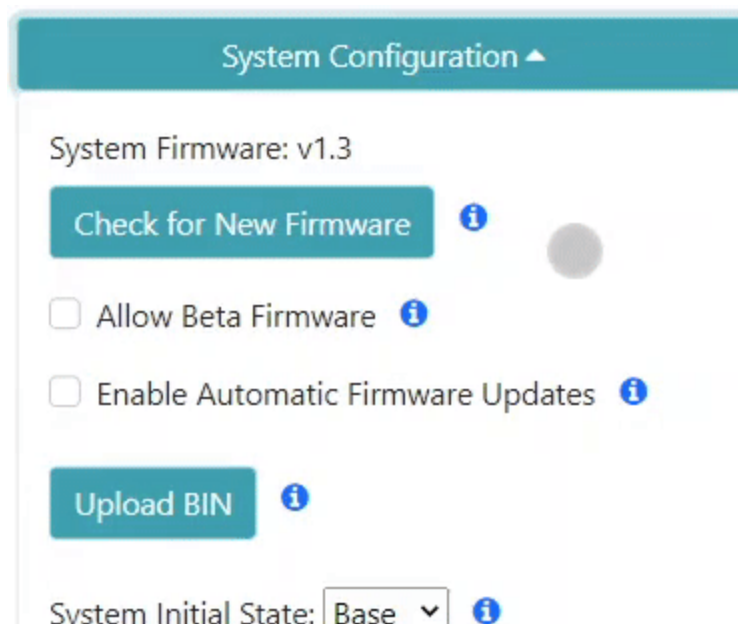

## Updating the firmware via WiFi config page

Firmware can be updated in the **System Configuration** section of the WiFi Config page. Automatic firmware updates is supported over WiFi, which makes checking and upgrading a unit simple. The polling period is specified in minutes and defaults to once a day. The automatic firmware update only checks for and installs the latest firmware release:

- Older released versions (continual upgrade)
- Locally built versions (newer or older, restore to released version)

## Updating Firmware From WiFi

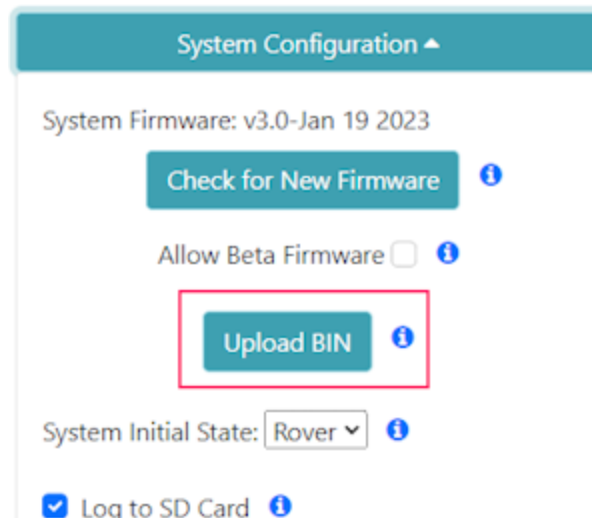

Firmware may be manually uploaded to the unit by clicking on **Upload BIN**, selecting the binary such as **RTK\_Surveyor\_Firmware\_v3\_x.bin** and pressing upload. The unit will automatically reset once the firmware upload is complete.

## Updating mosaic-X5 Firmware

The mosaic-X5 is the GNSS receiver used in the FPX. The following video describes how to update the firmware on the mosaic-X5.



## How to upgrade the firmware of a Septentrio rec

Septentrio



Watch on

1. Download the latest firmware released by Septentrio, listed on their [product page](#) for the mosaic-X5 module.

### **WARNING**

Currently, the RTK Everywhere firmware for the FPX does not support the latest firmware release from Septentrio. In `v4.15.0` Septentrio has added a security features with designated user credentials and is not simple to integrate with the existing code base. Therefore, we recommend that users remain on `v4.14.10.1` for the time being.



**Find the Latest Firmware**

2. Download and install the USB drivers to access the internal web server:
  - On Linux, the standard Linux CDC-ACM driver is suitable
  - On a Windows PC, the USB driver for the mosaic-X5 will need to be installed through two methods:
    - Installed with Septentrio's [RxTools software suite](#)
    - Install the USB driver that is available from the mass-storage device, which appears when the SparkPNT FPX is initially connected to the computer
3. With the USB driver installed, connect to the USB-C port of the FPX. The mosaic-X5 module supports Ethernet-over-USB and host an internal web server to configure the device.
  - The default IP address allocated for the Ethernet-over-USB interface is `192.168.3.1` and can be accessed from any web browser

4. Navigate to the **Admin** tab and select **Upgrade** from the drop-down menu
5. Click on **Choose File** to browse your computer and select the downloaded firmware file
  - Navigate to the downloaded folder, extract/unzip the files, open the `firmware` folder, and select the `*.suf` file
6. Hit the start upgrade button, a dialog box will display the progress of the upgrade
  - Once completed, an `Upgrade successful` message will appear
7. To verify the update, navigate to the **Admin** tab and click **About**
  - The new firmware version should be displayed

# Resources & Support

## **Technical Support**

A beginner's guide to get your device up and running

## **Warranty and Returns**

A full listing of our terms of service, warranty, returns process, etc.

## **Repair Manual**

A disassembly guide to replace or repair damaged components

## **Technical Resources**

Reference documentation and product specifications for technical users

# Technical Support

If you need technical assistance or more information on a product that is not working as you expected, please head over to our [SparkPNT Forum](#). Feel free to check out our [troubleshooting tips](#), below, for some suggestions on common topics.

## ⚠ ACCOUNT REGISTRATION REQUIRED

On your first visit to our forum, you'll need to create a [Forum Account](#) to post questions.

## Order and Shipping Issues

If your order was damaged, misplaced, or is missing any parts, please email our support team at [support@sparkpnt.com](mailto:support@sparkpnt.com). However, if your order was placed through one of our distributors please contact them first to resolve any issues.

## ⚠ INFO

For damaged or missing parts, please include a picture of your package's condition on arrival or inside the case, showing missing items to help expedite the process.

## Troubleshooting Tips

Below are some tips to troubleshoot common issues that users may come across.

### Galileo HAS

When utilizing corrections from the Galileo High Accuracy Service (HAS), users should expect an initial convergence time of ~10-12 minutes and an accuracy of <10 cm.

### Battery Life

When fully charged, the device should be able to operate continuously for over 24 hrs.

**!** INFO

It should be noted that the battery's capacity and efficiency will degrade over its lifetime. This is affected by several factors that include, but are not limited to the number of duty-cycles, discharge and charge rates, operating and storage temperatures, chemistry, manufacturing quality and defects, etc.

Users can order and replace their battery; check out our [disassembly instructions](#).

# **Warranty and Returns**

**Terms of Service**

**Returns Process**

# Repair Manual

This guide is provided to assist users that would like to repair or replace certain components on the board.

## Open the Enclosure

The FPX can be opened by removing the six Phillips head screws located on the bottom of the enclosure's antenna cap.



*Remove the screws of the enclosure for the antenna cover.*

Once unscrewed, the plastic cover should come right off, exposing the ceramic GNSS and WiFi/BLE antennas underneath.

## Remove the Antenna Stackup

Once the antenna cover is removed, users can access the six Phillips head screws holding the antenna PCB in place.

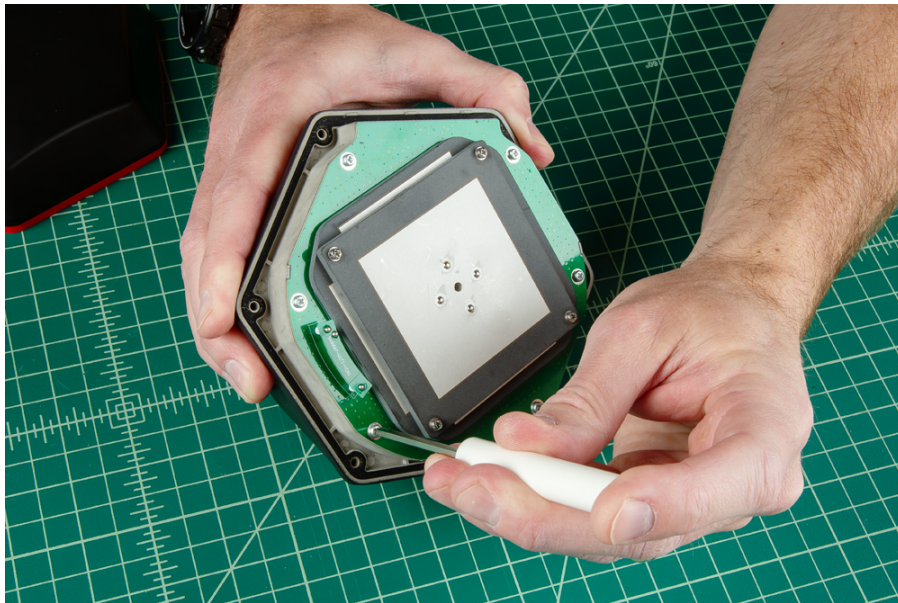

*Remove the screws holding the embedded antenna.*

With the screws removed, gently and very carefully lift the upper PCB antenna off the enclosure. There are two U.FL cables underneath the antenna, users will need to disconnect the cables from the mainboard PCB and GNSS Flex module.

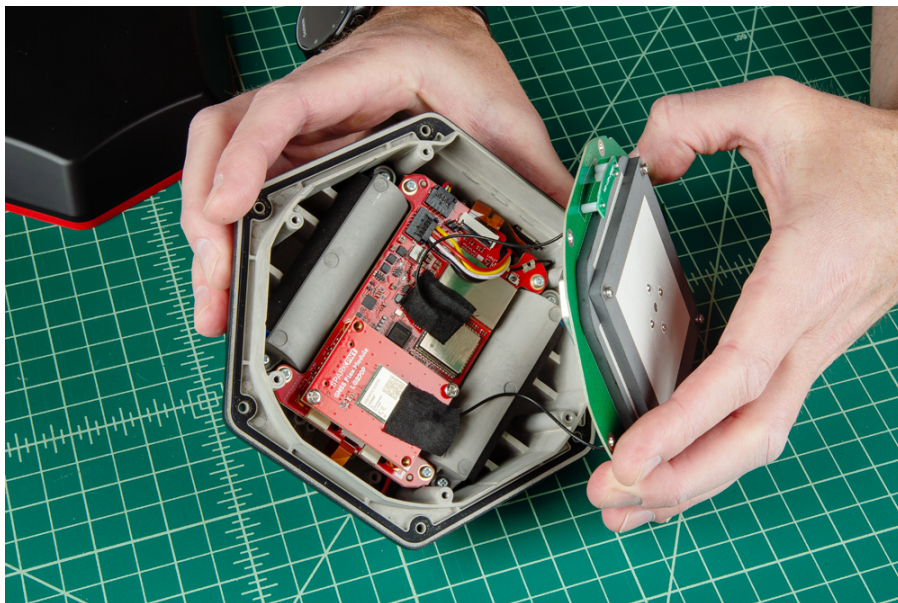

*Carefully, lift the PCB off the enclosure.*



**TIP**

Be careful removing the PCB as there are U.FL cables attaching the antenna to other components.

The U.FL connectors are held in place with a piece of tape, which must be removed to access them. Carefully disconnect the U.FL cable, users may want to use a [U.FL tool](#) to avoid damaging the connection.

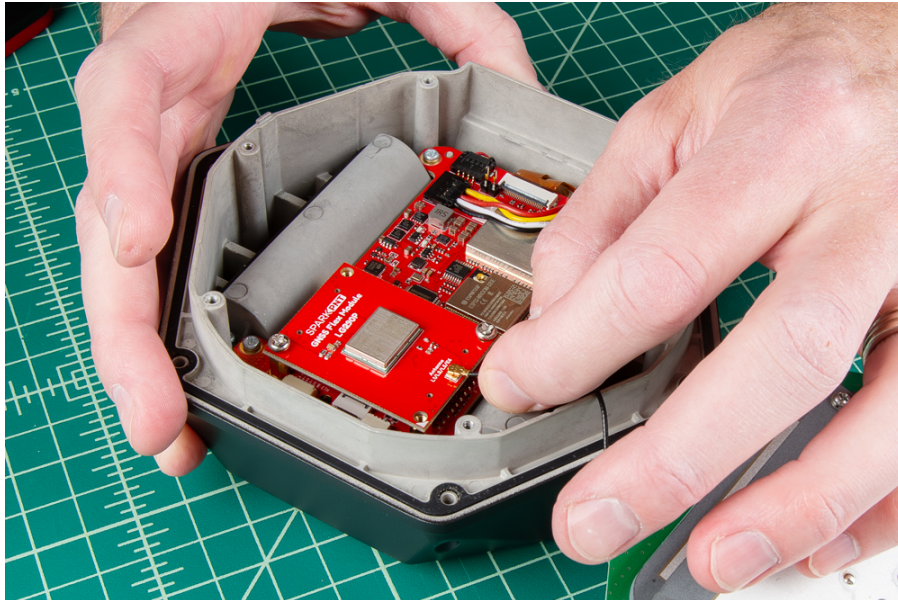

*Disconnect the U.FL cable attached to the GNSS Flex module.*

## Swap Antenna

With the antenna element removed, users can replace the part as necessary.

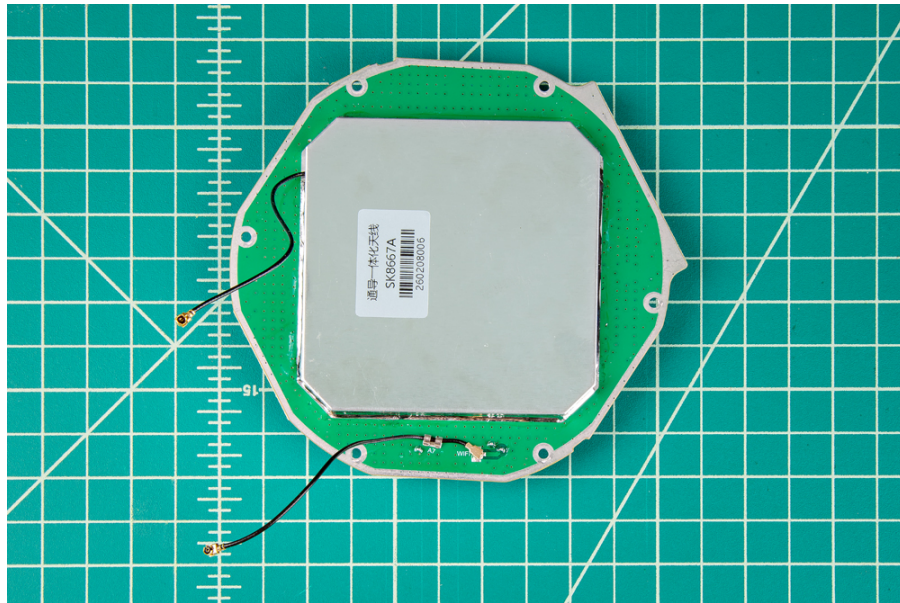

*The antenna element, removed from the FPX.*

#### **!** INFO

- The U.FL cable for the GNSS antenna will lead directly to the large metal cover of the antenna element.
- The U.FL cable for the WiFi/BLE antenna will lead directly to the PCB of the antenna element.

## Reattach Antenna

Once you have replaced all the necessary components, reconnect the U.FL cables from the antenna element to the mainboard and GNSS Flex module.



*Reconnect the U.FL cable to the GNSS Flex module.*

The U.FL cable for the GNSS antenna that comes from the large metal cover of the antenna element, needs to be connected to the GNSS Flex module. Meanwhile, the U.FL cable for the WiFi/BLE antenna that is attached directly to the PCB of the antenna element, should be connected to the mainboard.

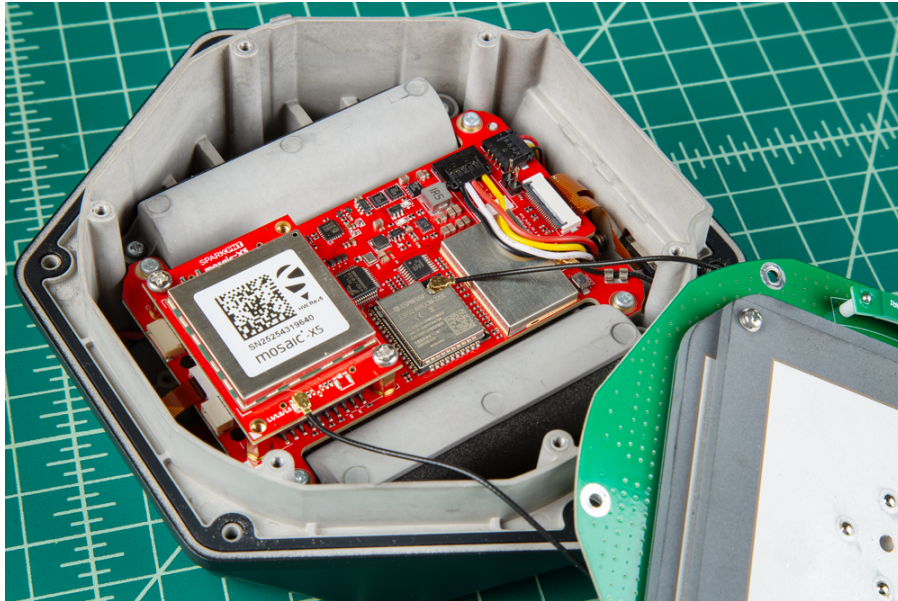

*U.FL cables attached to the FPX.*

After the cable have been connected, replace the tape that was removed, this helps keep the cables in place.

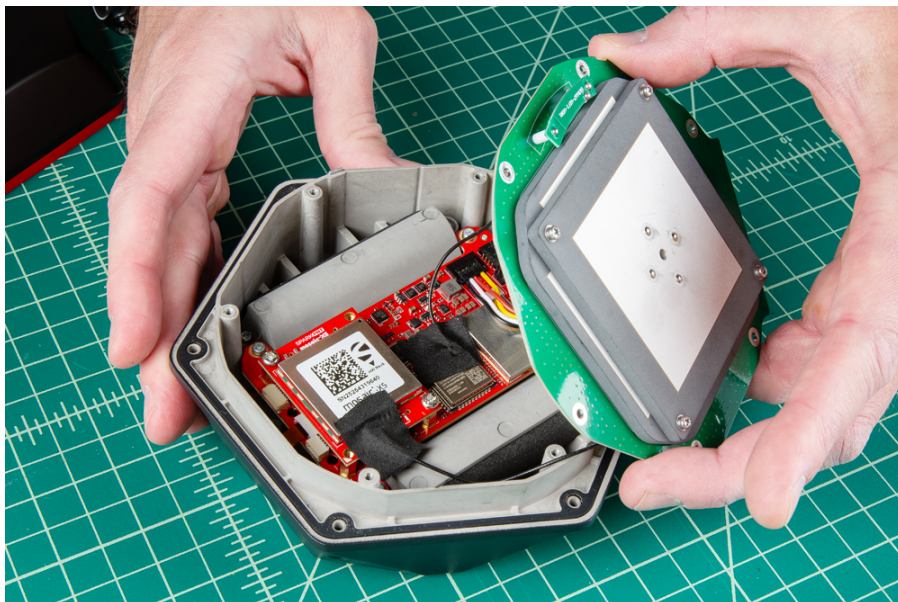

*U.FL cables attached to the FPX.*

The PCB of the antenna element is cut to align directly with the edges of the enclosure

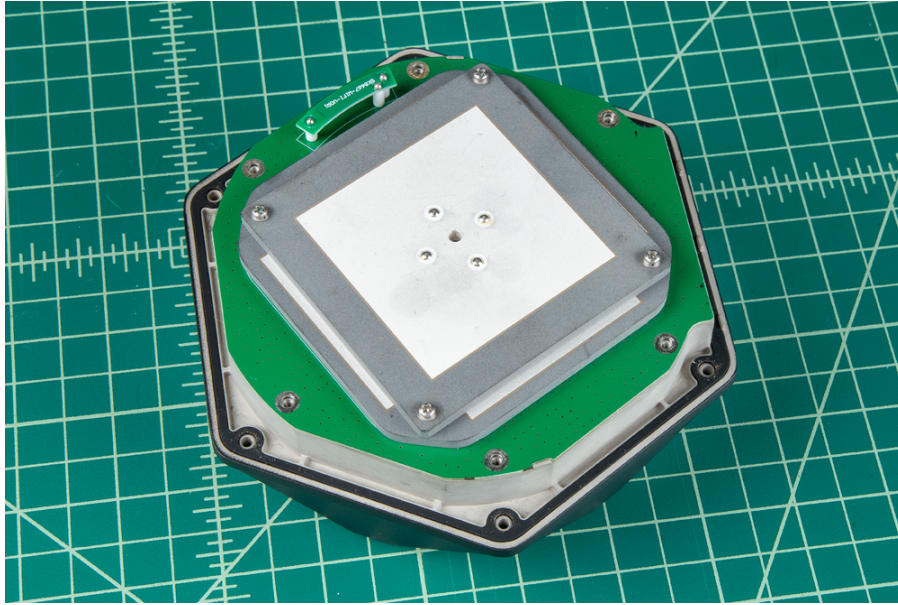

*The antenna element aligned with the enclosure.*

All that is left, is to secure the antenna and the enclosure cover with the screws that were removed earlier.

 **TIP**

- Don't forget to attach the silicone bumper with the enclosure's cover.
- Be careful when threading these screws back into the cover. Over tightening or cross threading the screws into their holes, can strip out the screw head or eventually weaken the material fastening the screw.

## Remove the GNSS Flex Module

Once the antenna stackup has been removed, users can access the Phillips head screws holding the GNSS Flex module in place.

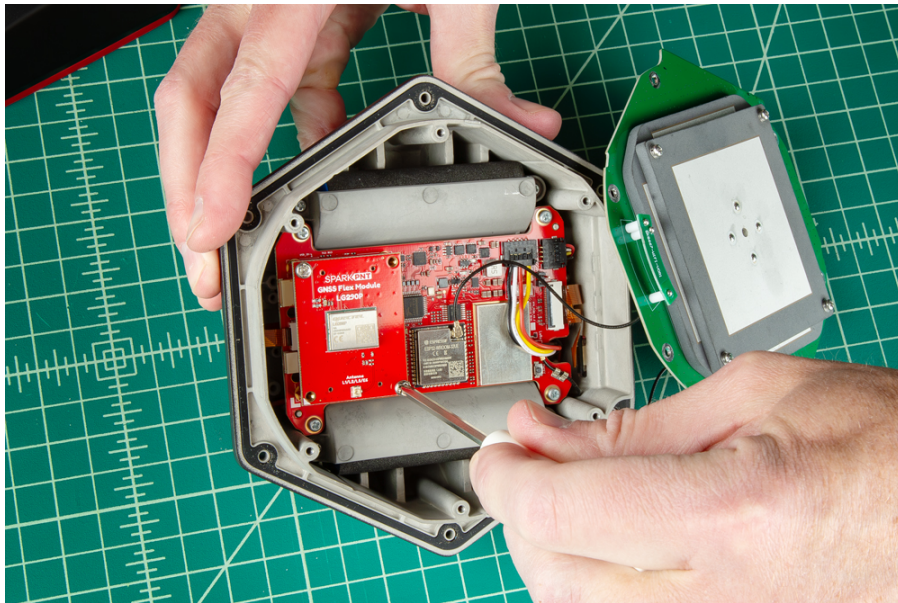

*Remove the screws holding the GNSS Flex module.*

## Swap Modules

For users that are just upgrading or replacing the GNSS Flex modules, carefully remove the GNSS Flex module. It is connected to the mainboard with two sets of 2x10-pin headers.

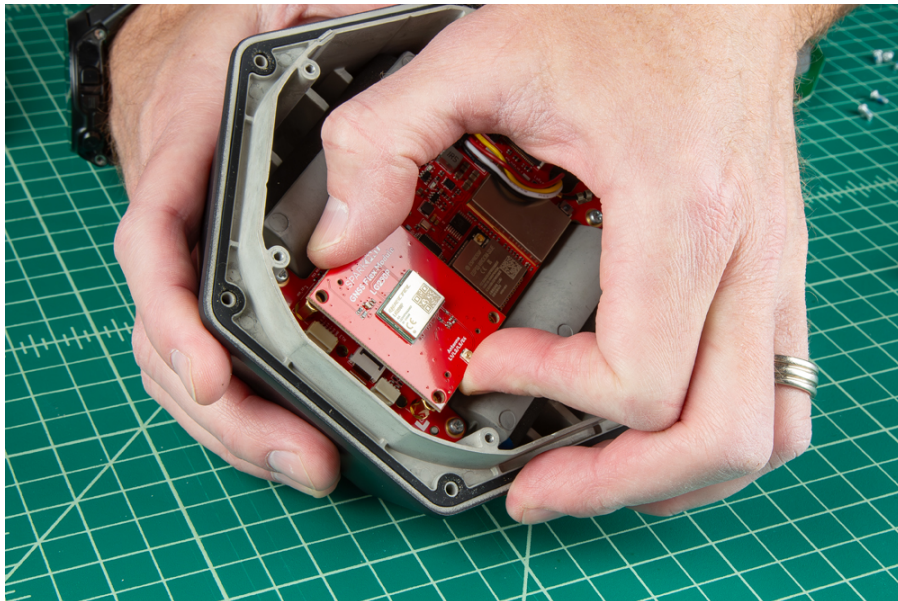

*Remove the GNSS Flex module from the FPX.*

Once removed, attach the new GNSS Flex module. Be careful to note the alignment of the boards as the header pins are symmetric. The alignment indicator on the GNSS Flex module (*circled below*),

should be pointing away from the display/user interface.

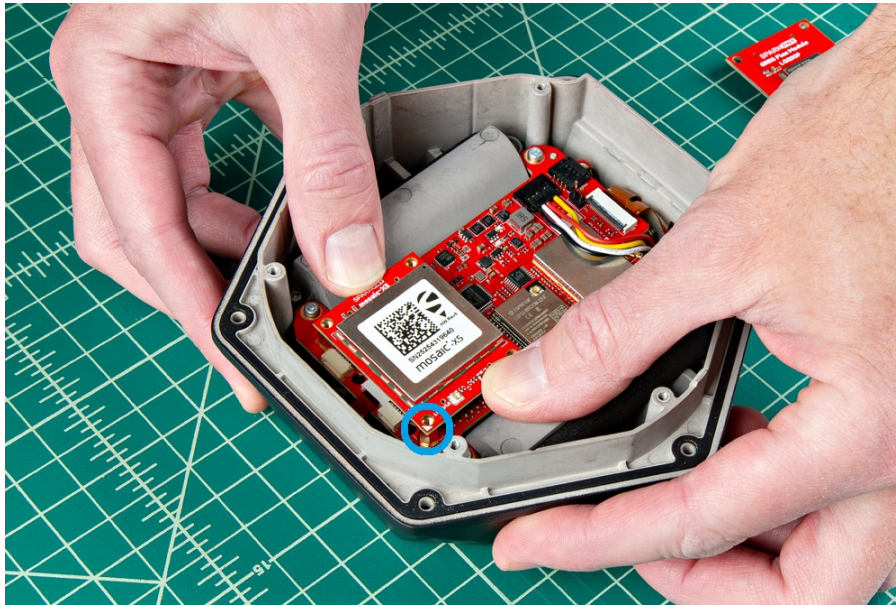

*Replace the GNSS Flex module.*

 **TIP**

- Ensure the position of the alignment indicator on the GNSS Flex module, is pointing away from the display interface.
- Be careful when threading these screws back into the cover. Over tightening or cross threading the screws into their holes, can strip out the screw head or eventually weaken the material fastening the screw.

## Remove the Mainboard PCB

Disconnect the four cables from the right-side and one cable on the left-side of the mainboard PCB. Then, remove the four Phillips head screws holding the mainboard PCB in place to free the board.

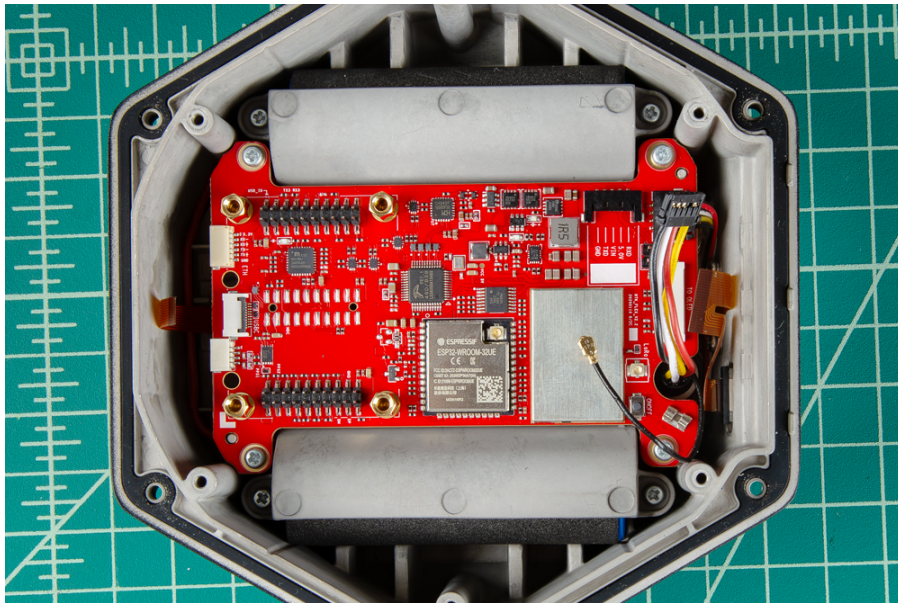

*Disconnected the cables from the mainboard.*

**i NOTE**

The UFL cable for the LoRa cable is secured in place with a wire crimp. Users should be able to slide the cable in-and-out of fixture, but be careful not to damage the components.

## Replace the Mainboard PCB

Once the unit has been serviced, we recommend reconnecting the cables to the mainboard before securing it to the enclosure. It will be easier to attach them before the board is in the enclosure

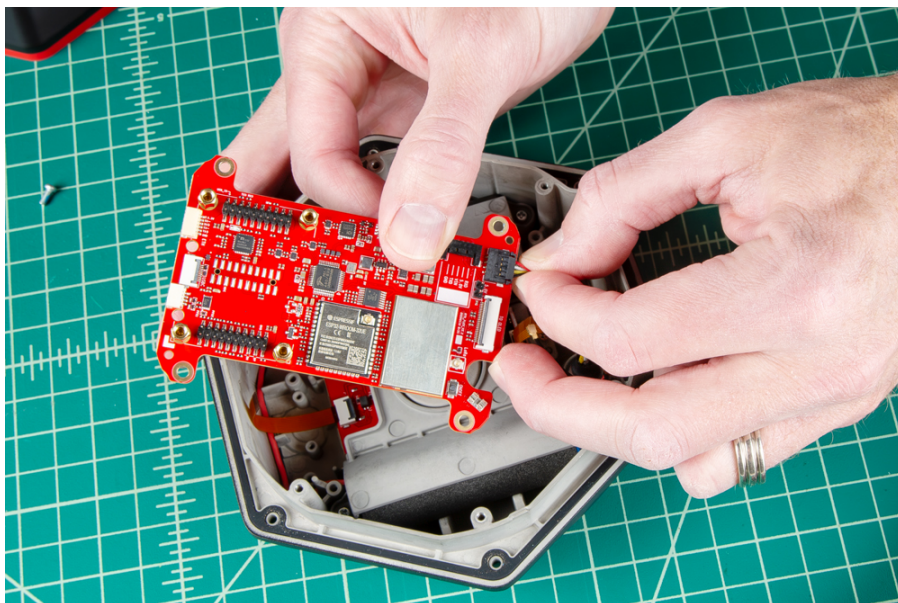

*Connected the cables on the mainboard.*

Once the cables have been attached, screw the mainboard back into the enclosure. Below, is an example of the components properly assembled, including the GNSS Flex module.

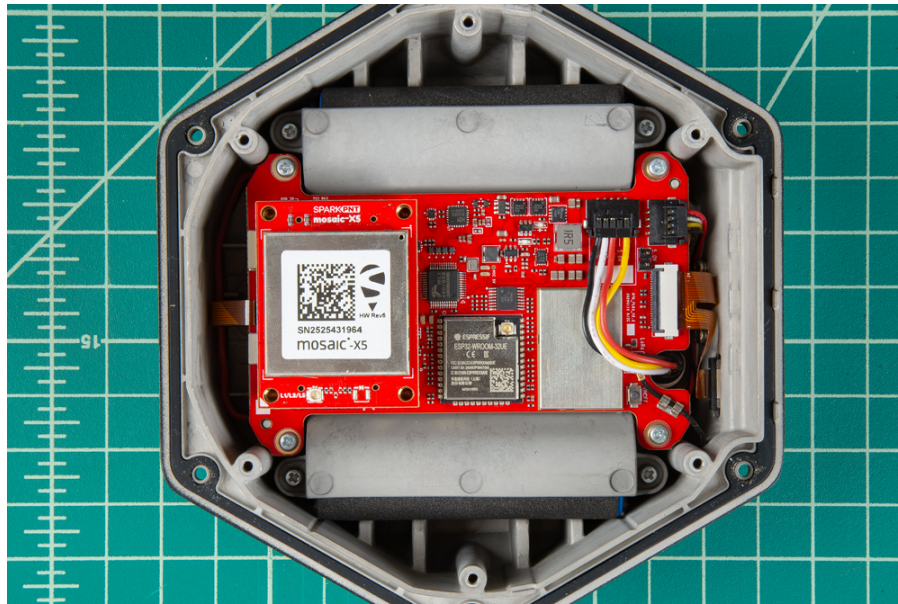

*These components properly reassembled in the enclosure.*



**TIP**

Be careful when threading these screws back in. Over tightening or cross threading the screws into their holes, can strip out the screw head or eventually weaken the material fastening the screw.

## Remove the Battery Plate

With the mainboard out of the way, the battery cover can be removed. Remove the four Phillips screws from the batteries' retainer plate.

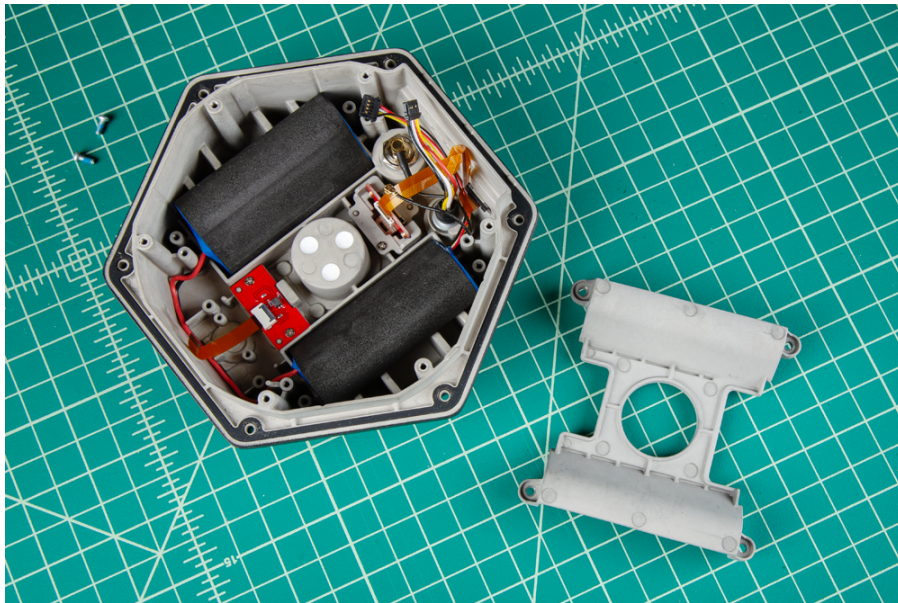

*Remove the screws from the battery's retainer plate.*

The 7.2V LiPo battery pack can be replaced and users can access the interface connections from the bottom of the SparkPNT FPX.

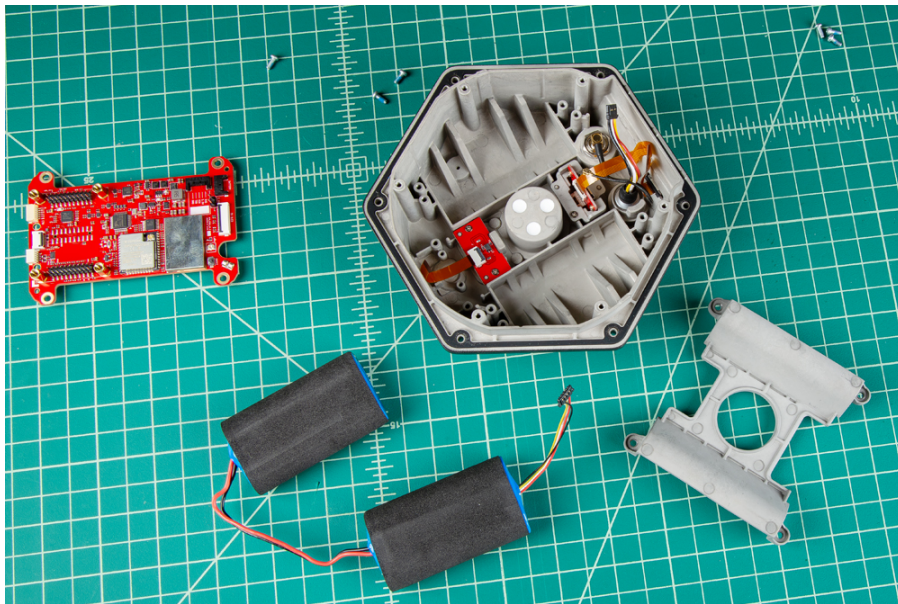

*Replace the battery and/or service the connections.*

 **TIP**

Be careful when threading the screws back into the cover. Over tightening or cross threading the screws into their holes, can strip out the screw head or eventually weaken the material fastening

the screw.

# Technical Resources

## Reference Documents

The latest firmware and technical documentation for the device

## Product Specifications

The hardware specifications for the device

# Reference Documents

## Latest Firmware

- [RTK Everywhere Firmware](#)
- [ZED-X20P Firmware](#)

## Technical Documentation

The following datasheets, manuals, and documents are available for the SparkPNT FPX:

- [RTK Everywhere Firmware - Product Manual](#)

# Product Specifications

Below are the full specifications for this device:

- mosaic-X5 GNSS Receiver
  - Supported Frequency Bands
    - GPS: L1C/A, L1C, L2C, L5
    - GLONASS: L1, L2
    - Galileo: E1, E5a, E5b, E6
    - Beidou: B1I, B2I, B3I, B1C, B2a, B2b
    - QZSS: L1C/A, L1C, L2C, L5, L6
    - NavIC: L5
    - SBAS: L1
  - Accuracy:
    - Autonomous:
      - Horizontal: 0.7m
      - Vertical: 2.5m
    - RTK:
      - Horizontal: 8mm + 1ppm
      - Vertical: 15mm + 1ppm
  - Time to Fix: <28s
- Antenna
  - L1, L2, L5, L6
    - Gain:  $\geq 2.3\text{dBi}$
    - APC (NGS Calibrated):
      - L1: 65.7mm
      - L2/L5: 50.9mm
      - Average: 58.3mm
  - WiFi, BLE
    - 2.4GHz
- Enclosure
  - Ingress Protection: IP67 (1m of water for 30 minutes)

- Materials: Aluminum body w/ plastic cap
- Single push button control
- Three LED indicators
- USB-C port w/ rubber cover
- Battery
  - Specs: 7.2V 6800mAh (48.96Whr)
  - Charging: up to 10W
  - Run Time: 32hrs
- Dimensions: 71 x 71 x 147mm (2.8 x 2.8 x 5.8in)
- Weight: 423g (0.93 lbs)